



WILBUR CURTIS COMPANY, INC.

Service Manual, D60GT

Models Included

- D60GT

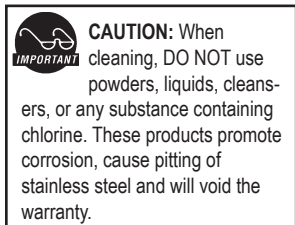
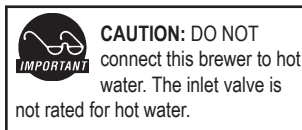

Important Safeguards/Conventions

This appliance is designed for commercial use. Any servicing other than cleaning and maintenance should be performed by an authorized Wilbur Curtis service center.

- Do NOT immerse the unit in water or any other liquid
- To reduce the risk of fire or electric shock, do NOT open top or rear panel. No user serviceable parts inside. Repair should be done only by authorized service personnel.
- Keep hands and other items away from hot parts of unit during operation.
- Never clean with scouring powders, bleach or harsh implements.

Conventions



WARNINGS – To help avoid personal injury



Important Notes/Cautions – from the factory



Sanitation Requirements

Your Curtis G3 System is Factory Pre-Set and Ready to Go... Right from the Carton.

Following are the Factory Settings for your D60GT

Coffee Brewing Systems:

- **Brew Temperature = 200° F**
- **Brew Volume = Set to dispensing vessel requirements (60 oz)**

Generally there will never be a reason to change your G3 programming. However, should you need to make slight adjustments to meet your brewing needs, programming instructions are provided later in this manual.

System Requirements:

- **Water Source** 20 – 90 PSI. Must have a minimum flow rate of ½ GPM (preferred flow rate is 1 gpm).
- **Electrical:** See attached schematic for standard model or visit www.wilburcurtis.com for your model.

Equipment to be installed to comply with applicable federal, state, or local plumbing/electrical codes having jurisdiction.

SETUP STEPS

The unit should be level (left to right and front to back), located on a solid counter top. Connect a water line from the water filter to the brewer. **NOTE:** Some type of water filtration device must be used to maintain a trouble-free operation. (In areas with extremely hard water, we suggest that a sedimentary and taste & odor filter be installed.) This will prolong the life of your brewing system and enhance coffee quality.



NSF International requires the following water connection:

1. A quick disconnect or additional coiled tubing (at least 2x the depth of the unit) so that the machine can be moved for cleaning underneath.
2. This equipment is to be installed with adequate backflow protection to comply with applicable federal, state and local codes..
3. Water pipe connections and fixtures directly connected to a potable water supply shall be sized, installed and maintained in accordance with federal, state, and local codes.

1. A 3/8" NPT x 1/4" Flare elbow has been supplied for water line connection. Use adequate water tubing, sized to provide a minimum of ½ GPM.
2. Connect the unit to an appropriate electrical power circuit.
3. Turn on the toggle (STANDBY/ON) switch behind the unit. The heating tank will start to fill. When the water level in the tank rises to the correct volume, the heating element will energize automatically. G3 systems eliminate element burn-out due to an under-filled heating tank.
4. The heating tank will require 20 to 30 minutes to reach operating temperature (200°F), indicated by the READY-TO-BREW light.
5. Prior to brewing, dispense 12 ounces of hot water through the hot water faucet.
6. Brew a cycle of at least 12 ounces, to purge the water lines of any air that may be trapped after filling.

BREWING INSTRUCTIONS

1. Brewer should be ON (Confirm at rear toggle switch, then press ON/OFF button). Ready-to-Brew should be displayed.
2. Place a clean, empty decanter on brew deck.
3. Place a new filter in brewcone.

4. Pour ground coffee into brewcone.

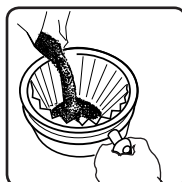

5. Position brewcone into brew rails.

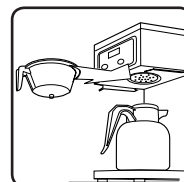

6. Press Brew button.

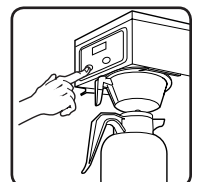

WILBUR CURTIS COMPANY
Montebello, CA 90640



FOR THE LATEST SPECIFICATIONS AND INFORMATION GO TO WWW.WILBURCURTIS.COM

Quick Start

D60GT

Your Curtis ADS System is Factory Pre-Set for Optimum Performance.

After connection to water and power; the rear toggle switch must be on. You will hear a beep sound, indicating power is available to the controller.



The control displays . Press ON/OFF button and the screen will display . After three seconds,  is displayed.

Water will fill the tank (approximately 2-3 minutes depending on water flow rate). When the proper level is reached  will appear on the screen. It takes approximately 20 minutes to reach setpoint temperature of 200°F.

Control will display  when temperature reaches the setpoint (200°F). Unit is now ready to brew.

To Go Into Programming



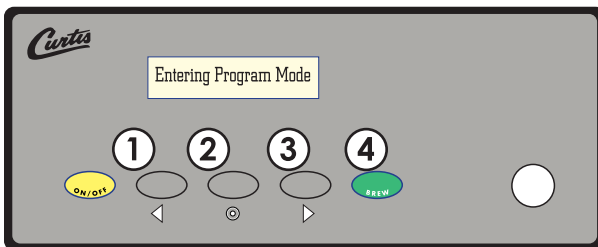

Turn off (dark display) by pressing **ON/OFF** button (yellow). Press and hold **BREW** button (green) and then press and release **ON/OFF** button (yellow).

Continue holding **BREW** button. Display will read , wait until  is displayed. Enter the 4-digit access code, the digits 1-4 correspond to the buttons (see illustration below).

The default code set at the factory is 1-2-3-4. Then  will be displayed.



All programming selections are performed with the three center buttons. The symbols below the buttons are:

-  Scroll LEFT
-  SELECTION or ENTER to save new parameter
-  Scroll RIGHT
- Exit Press  to select, exits program mode and returns unit to operation.

PROGRAM MENUS



Model Select – Always perform this first. This feature re-sets all settings to the factory defaults.

Scroll through menu to Model Select. Choices are ALPHA-1, ALPHA-2, ALPHA-3/4/5, Airpot Brewer and Thermo-Alpha. Select only Thermo-Alpha.

Brew Volume

Selecting Brew by Volume or Brew by Time depends on whether you know your brew time before starting. From Program Menus press > display will now show the next feature.





During the actual brew cycle, a 2-minute drip mode is added to the brew time. The programmed water level compensates for back to back brewing Delta 3 to allow for an increase of water volume.



Brew by Volume (Factory set to 60 oz.)

Press  to Select, Display will now show Push START To Begin... Press the BREW button then hot water starts running, when desired volume is reached press BREW button again to stop the flow. Now the volume has been set. Pressing > button will display the subsequent menu features.



Brew by Time (Factory set to 2 min – 40 sec).

Press  to Select to change the brew time. Display will now show the current time. By pressing < or > you can toggle back and forth from minutes to seconds to exit (ex). Change the time or set and exit by pressing .

Temperature (Factory set to 200°F)

Press  to Select. Press < or > to move to desired temperature and then  to set. Temperature is programmable from 170°F to 206°F in 2-degree increments.

Energy Save Mode (Factory set to OFF)

Press  to Select, < or > ON, OFF or ON 140°F,  to set. When in ON, unit will automatically shut off 4 hours from last brew. When feature is OFF, unit does not have the energy saving mode. In the ON 140°F position, temperature goes down to 140°F if unit has not brewed in 4 hours. This feature will save energy by lowering the tank temperature during periods of non-operation.

Brew Count Odom.

Press  to display total gallons brewed. Press ex or Reset

Pre-Infusion (Factory set to OFF)

Press \odot to Select. Current setting in seconds is displayed < to decrease or select > to increase (range from OFF to 10 through 60 seconds), \odot to set.



If Pre-infusion is selected (ON), Cold Brew Lock is set to Delta 1 within 5°F of set point and Cold Brew Lock disappears from the list of program selections. When Pre-infusion is ON, Pulse Brew disappears from the list of program selections.

Brew Count Total

Press \odot to Select, Shows total gallons and total brew cycles on the unit. Not resettable.

Cold Brew Lock . . . (Factory set to 15°)

Press \odot to select, < or > to select desired setting (CBL 5, 15 or OFF), \odot to set. .

The Cold Brew Lock feature allows the brewer to brew at three different temperature levels from the actual set point. The first setting is within 5 degrees of set point, next is within 15 degrees of set point, OFF is within 30 degrees of set point for the Ready to Brew message, however it will brew at any temperature. This feature will operate after initialization to set temperature after the rear standby toggle switch is reset to ON.

Master Reset

Press \odot to display **Are You Sure?** Then < for **Yes**, > for **No**. Brewer factory defaults are then reset.

Service Call (Phone number Factory set to [800] 995-0417)

Press \odot to display number and change number or < to move place and EX to exit when complete This number will be displayed during a Heating system SENSOR ERROR or during a WATER ERROR.

Access Code (Factory set to 1-2-3-4)

Press \odot to display number and change number, (the number can be change 1 to 4) or < to move place and ex to exit when complete.

Banner Name (Factory set to Curtis)

Press \odot to display letters and change letters or < to move place and EX to exit when complete. This feature allows up to 14 letters to be programmed for company name or regional name. Programming all blanks disables Banner Name. If programmed, Banner Name is displayed every 5 sec. on and off.

P-Maintenance (Factory set to OFF)

Press \odot to Select, Set gallons brewed to indicate P-Maintenance. Press < or > to adjust from Off to 3000 gallons. Press \odot to exit.

Beeper On/Off (Factory set to ON)

Press \odot to display ON or OFF. Pressing either < or > toggles between on and off. \odot to set.

Pulse Brew (Factory setting OFF)

Press \odot to select, < or > to select OFF or one of four pulse patterns (A to E) .

Guidelines for Pulse Brew:

This feature allows tuning of the coffee flavor. The pot level should always be set first with this option OFF. Depending on your grind profile and water conditions, the five Pulse Brew options help "tune" or change the coffee flavor. Filter Pack type coffees typically extract better with the A and B pulse setting. Decaffeinated coffees typically extract better with the B pulse setting. High-Yield coffees typically extract better with the C pulse setting. Of course, any of the A, B or C settings may be used to suit your taste profile. There are two additional settings (D and E) that allow you to manually set the ON TIME pulses and OFF TIME.



If Pulse Brew is selected (ON), Cold Brew Lock is set to Delta 1 within 5°F of set point and Cold Brew Lock does not appear the list of program selections. When Pulse Brew is ON, Pre-infusion disappears from the list of program selections.

Display Brew Time (Factory set to ON). Press \odot to display ON or OFF. Pressing either < or > toggles between on and off. \odot to set. When on, the Display Brew Time feature allows you to see the remaining time in the brewcycle counting down.

Drip-Out Mode (Factory set to 2 min) Press \odot to select. Press > to increase time (to a maximum of 5 minutes) or < to decrease the time and turn OFF. Time counts up in 5 second increments. Press \odot to set.

Model Select Press \odot to select, < or > to select model. The selections are: ALPHA-1, ALPHA-2, ALPHA-3/4/5, Airpot Brewer, Thermo-Alpha (for the D60GT). Press \odot to set. When the Model Select feature is changed, all settings are reset to the defaults of the newly selected model.

Exit Press \odot to select, exits program mode and returns unit to operation.

ADDITIONAL UCM FEATURES

Brew Volume – Easy Access

Units produced beginning January 2008 can be easily adjusted from the front panel. Written into the software on the D60GT UCM, is a feature to access the brew volume without entering the program mode.

The UCM must be on. To adjust the D60GT model, press and hold down the center, Select button $\textcircled{2}$. The screen will read

Vol. Adj. < -0 > Oz.
- Select +

 pressing < or > will adjust the brew volume up or down, \pm 20 oz, in 1 ounce increments.

Tank Temperature Check

Turn on brewer at the control panel ON/OFF button. Press and hold $\textcircled{3}$ button (see illustration, page 2) for 5 seconds. Water Temperature will be displayed.

**ILLUSTRATED
PARTS**

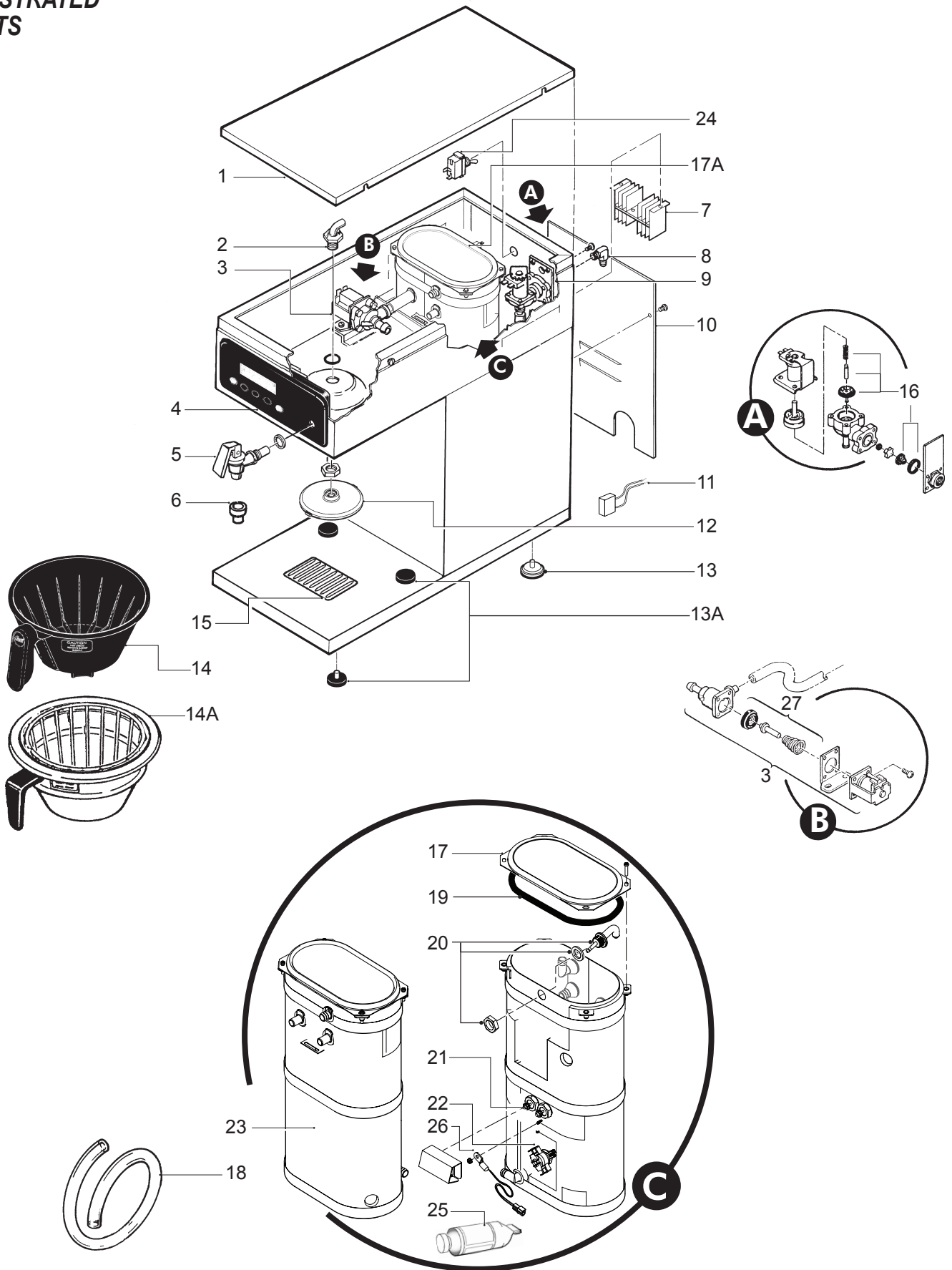

PARTS LIST

Item	Part No.	Description	Item	Part No.	Description
1	WC-58117	COVER, TOP D60GT	13A	WC-3503	LEG, SCREW BUMPER (3/8")
2	WC-2962	FITTING, SPRAYHEAD ASSY PLATED	14	WC-3621-101	BREW CONE, UNIVERSAL 7.38" DIA.
2B	WC-2977-101	FITTING, SPRAYHEAD ULTEM (OLDER UNITS)	14A	WC-3316	BREW CONE, ASSY S.S. (OPTIONAL)
2A	WC-2977	FITTING, SPRAYHEAD PLATED (OLDER UNITS)	15	WC-6221	SCREEN, DRIP TRAY SS (OPTIONAL)
3	WC- 889*	VALVE, DUMP LEFT 120V 12W	16	WC-3765L*	KIT, VALVE REPAIR (FOR WC-826 VALVE)
4	WC-37064*	KIT, LABEL & UCM D500/D60GT CURTIS	17	WC-5853-102	COVER, TOP HEATING TANK
5	WC-37252	KIT, HOT WATER FAUCET REPLACEMENT	17A	WC-5851	LID, HEATING TANK (OLDER UNITS)
6	WC-1806	SEAT CUP, SILICONE (FOR WC-1809 FAUCET)	18	WC-5310*	TUBING, 5/16 ID SILICONE GEN USE
7	WC-8556*	HEAT SINK ASSEMBLY DV	19	WC-43062	GASKET, TANK LID
8	WC-2401	ELBOW, 1/4 x 3/8 FLARE	20	WC-37278*	KIT, LIQUID LEVEL PROBE GT
9	WC- 826L*	VALVE, INLET 1.0 GPM 120V	21	WC- 917-04*	HEATING ELEMENT, 1450W 120V
10	WC-5970	COVER, BACK CTR WRAP ALPHA/D60GT	22	WC- 523*	THERMOSTAT, MANUAL RESET
11	WC-8591	CAPACITOR, X2 USED ON ALL ADS MODELS	23	WC-6289	HEATING TANK CMPLT, 120V W/HIGH LMT T-ST
12	WC-29025*	SPRAYHEAD, PURPLE ADVANCE FLOW	24	WC- 102*	SWITCH, TOGGLE SPST 25A 125/250VAC
12A	WC-29050*	SPRAYHEAD, AMBER (OLDER UNITS)	25	WC-5231*	COMPOUND, SILICONE 5 OZ TUBE
12B	WC-2936*	SPRAYHEAD, RED .131 DIA (OLDER UNITS)	26	WC-1438-101*	SENSOR, TEMPERATURE TANK
13	WC-3518	LEG, GLIDE 3/8"-16 STUD SCREW	27	WC-3763*	KIT, VALVE REPAIR (FOR WC-889, DUMP VALVE)

* Recommended Parts to Stock.

ELECTRICAL SCHEMATIC

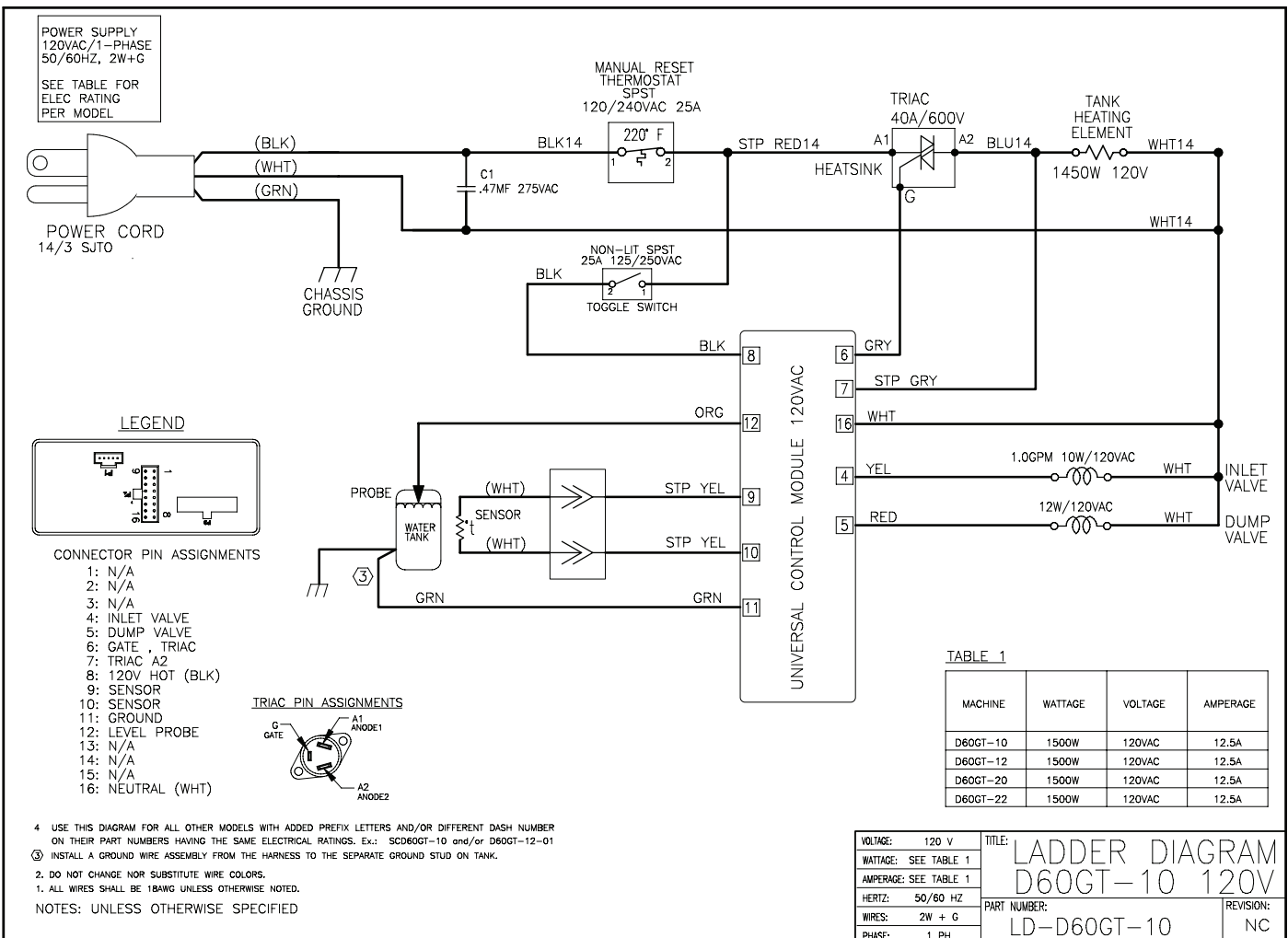

Product Warranty Information

The Wilbur Curtis Company certifies that its products are free from defects in material and workmanship under normal use. The following limited warranties and conditions apply:

3 Years, Parts and Labor, from Original Date of Purchase on digital control boards.

2 Years, Parts, from Original Date of Purchase on all other electrical components, fittings and tubing.

1 Year, Labor, from Original Date of Purchase on all electrical components, fittings and tubing.

Additionally, the Wilbur Curtis Company warrants its Grinding Burrs for Forty (40) months from date of purchase or 40,000 pounds of coffee, whichever comes first. Stainless Steel components are warranted for two (2) years from date of purchase against leaking or pitting and replacement parts are warranted for ninety (90) days from date of purchase or for the remainder of the limited warranty period of the equipment in which the component is installed.

All in-warranty service calls must have prior authorization. For Authorization, call the Technical Support Department at 1-800-995-0417. Effective date of this policy is April 1, 2003.

Additional conditions may apply. Go to www.wilburcurtis.com to view the full product warranty information.

CONDITIONS & EXCEPTIONS

The warranty covers original equipment at time of purchase only. The Wilbur Curtis Company, Inc., assumes no responsibility for substitute replacement parts installed on Curtis equipment that have not been purchased from the Wilbur Curtis Company, Inc. The Wilbur Curtis Company will not accept any responsibility if the following conditions are not met. The warranty does not cover and is void under the following circumstances:

- 1) **Improper operation of equipment:** *The equipment must be used for its designed and intended purpose and function.*
- 2) **Improper installation of equipment:** *This equipment must be installed by a professional technician and must comply with all local electrical, mechanical and plumbing codes.*
- 3) **Improper voltage:** *Equipment must be installed at the voltage stated on the serial plate supplied with this equipment.*
- 4) **Improper water supply:** *This includes, but is not limited to, excessive or low water pressure, and inadequate or fluctuating water flow rate.*
- 5) **Adjustments and cleaning:** *The resetting of safety thermostats and circuit breakers, programming and temperature adjustments are the responsibility of the equipment owner. The owner is responsible for proper cleaning and regular maintenance of this equipment.*
- 6) **Damaged in transit:** *Equipment damaged in transit is the responsibility of the freight company and a claim should be made with the carrier.*
- 7) **Abuse or neglect (including failure to periodically clean or remove lime accumulations):** *Manufacturer is not responsible for variation in equipment operation due to excessive lime or local water conditions. The equipment must be maintained according to the manufacturer's recommendations.*
- 8) **Replacement of items subject to normal use and wear:** *This shall include, but is not limited to, light bulbs, shear disks, "O" rings, gaskets, silicone tube, canister assemblies, whipper chambers and plates, mixing bowls, agitation assemblies and whipper propellers.*
- 9) **Repairs and/or Replacements** *are subject to our decision that the workmanship or parts were faulty and the defects showed up under normal use. All labor shall be performed during regular working hours. Overtime charges are the responsibility of the owner. Charges incurred by delays, waiting time, or operating restrictions that hinder the service technician's ability to perform service is the responsibility of the owner of the equipment. This includes institutional and correctional facilities. The Wilbur Curtis Company will allow up to 100 miles, round trip, per in-warranty service call.*

RETURN MERCHANDISE AUTHORIZATION: *All claims under this warranty must be submitted to the Wilbur Curtis Company Technical Support Department prior to performing any repair work or return of this equipment to the factory. All returned equipment must be repackaged properly in the original carton. No units will be accepted if they are damaged in transit due to improper packaging. **NO UNITS OR PARTS WILL BE ACCEPTED WITHOUT A RETURN MERCHANDISE AUTHORIZATION (RMA). RMA NUMBER MUST BE MARKED ON THE CARTON OR SHIPPING LABEL.** All in-warranty service calls must be performed by an authorized service agent. Call the Wilbur Curtis Technical Support Department to find an agent near you.*



WILBUR CURTIS CO., INC.

6913 Acco St., Montebello, CA 90640-5403 USA

Phone: 800/421-6150 Fax: 323-837-2410

Technical Support Phone: 800/995-0417 (M-F 5:30A - 4:00P PST) E-Mail: techsupport@wilburcurtis.com

Web Site: www.wilburcurtis.com

FOR THE LATEST SPECIFICATION INFORMATION GO TO WWW.WILBURCURTIS.COM