

ADVANTEDGE™ SANDWICH FOOD PREP REFRIGERATORS

SANDWICH FOOD PREP REFRIGERATORS



PROJECT:
.....
ITEM NUMBER:
.....
MODEL NUMBER:
.....

SPECIFICATIONS FOR: NLSP27-8, NLSP36-10, NLSP48-12, NLSP60-16, NLSP72-18

- **Finish:** Stainless steel interior and exterior
- **Insulation:** Complete cabinet and doors are foamed-in-place with polyurethane insulation
Insulated pan cover
- **Hardware:** Curved handle with recessed pocket with one epoxy coated shelf per door, 6" diameter casters standard
- **Electrical:** 115 volt, 60 Hz, 1 phase with cord and plug
- **Refrigeration:** Self-contained forced air refrigeration system. The condensate is collected and automatically evaporated from an energy efficient hot gas style vaporizer. Refrigerant flow is controlled by a capillary tube. R-134a refrigerant. Temperature range: +34°F to +38°F for storage area, +33°F to +41°F for refrigerated pan well.
- **Accessories:** 1/6 size pans and 9-1/2" polyethylene cutting board included
- **Approvals:** UL, C-UL Safety and ETL Sanitation listed **

STANDARD FEATURES

- 1/6 size pans included
*Note: NLSP27-8 has (6) 1/6 size pans and (2) 1/9 size pans included.
- Air cooled condensing unit
- Automatic condensate vaporizer
- Automatic defrost
- Capillary tube system
- Casters
- Cutting board

OPTIONAL FEATURES*

- Magnetic gaskets
- Self-closing doors
- Stainless steel interior and exterior
- UL, C-UL Safety and ETL Sanitation listed **
- Warranties: 3 year parts & labor, 5 year compressor
- Additional shelves
- Overshelf assemblies
- Pull-out drawers

* Most options are available two weeks from receipt of order. Please contact us for specific questions.
** C-UL is Underwriters Laboratories Safety Certification Mark which indicates that UL has tested the equipment to applicable CSA Standards.
** ETL Sanitation is Intertek Labs Sanitation Safety Certification Mark which indicates that ETL has tested the equipment to applicable NSF Standards.

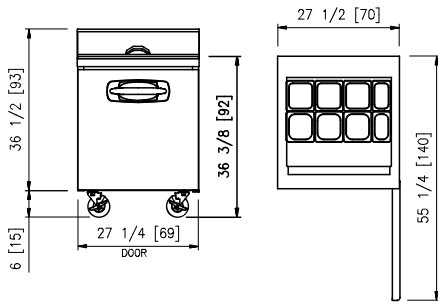

FRONT
NLSP27-8

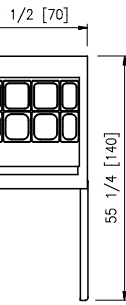

TOP

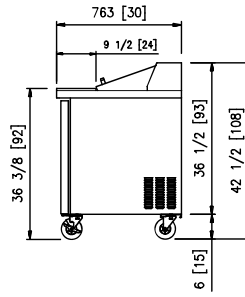

SIDE
ALL MODELS

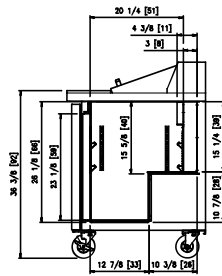

SIDE INTERIOR
ALL MODELS

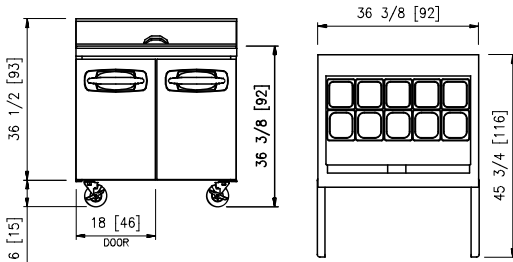

FRONT
NLSP36-10

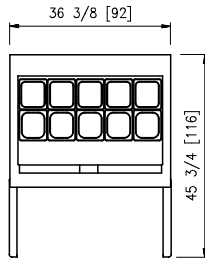

TOP

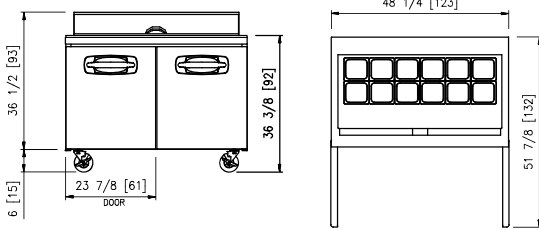

FRONT
NLSP48-12

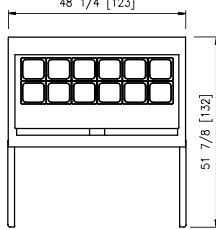

TOP

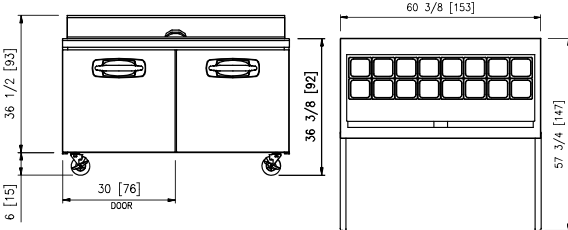

FRONT
NLSP60-16

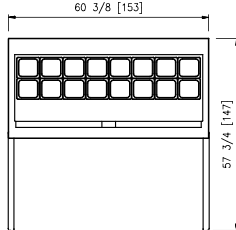

TOP

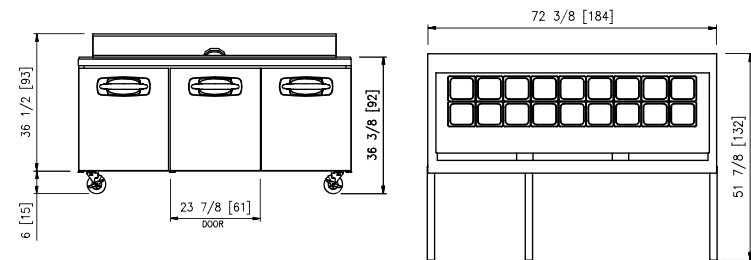

FRONT
NLSP72-18

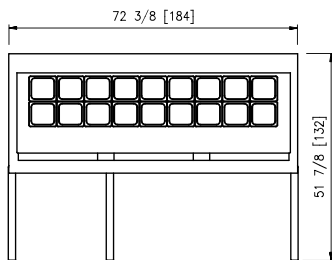

TOP

SPECIFICATIONS

Models	NLSP27-8	NLSP36-10	NLSP48-12	NLSP60-16	NLSP72-18
Crated Weight (lbs) (kg)	212 (95)	268 (121)	304 (137)	344 (155)	384 (173)
Crated Height (in) (cm)	42-7/8 (107)	42-7/8 (107)	42-7/8 (107)	42-7/8 (107)	42-7/8 (107)
Crated Width (in) (cm)	30-1/8 (75)	37-1/4 (93)	51-1/8 (128)	63 (158)	74-3/8 (186)
Crated Depth (in) (cm)	33-1/2 (84)	33-1/2 (84)	33-1/2 (84)	33-1/2 (84)	33-1/2 (84)
Interior Height (in) (cm)	20 (51)	20 (51)	20 (51)	20 (51)	20 (51)
Interior Width (in) (cm)	23-3/4 (59)	32-3/4 (82)	44-5/8 (112)	56-3/4 (142)	68-5/8 (172)
Interior Depth (in) (cm)	20-1/4 (51)	20-1/4 (51)	20-1/4 (51)	20-1/4 (51)	20-1/4 (51)
Overall Height (in) (cm)	42-1/2 (106)	42-1/2 (106)	42-1/2 (106)	42-1/2 (106)	42-1/2 (106)
Overall Width (in) (cm)	27-1/2 (69)	36-3/8 (91)	48-1/4 (121)	60-3/8 (151)	72-3/8 (181)
Overall Depth (in) (cm)	30 (75)	30 (75)	30 (75)	30 (75)	30 (75)
Gross Cubage (CuFt) (L)	7 (198)	10 (283)	13 (368)	16 (453)	20 (566)
Number of 1/6 Pans	8 *	10	12	16	18
Number of Shelves	1	2	2	2	3
Shelf Area (SqFt) (Sqm)	4.82 (0.45)	7.02 (0.65)	9.25 (0.86)	12.35 (1.15)	14.19 (1.32)
Number of Casters	4	4	4	4	4
Condensing Unit Size	1/5 HP	1/5 HP	3/8 HP	3/8 HP	3/8 HP
Refrigerant	R-134a	R-134a	R-134a	R-134a	R-134a
Electrical Characteristics	115/60/1	115/60/1	115/60/1	115/60/1	115/60/1
Cord and Plug Furnished	Yes	Yes	Yes	Yes	Yes
NEMA Plug Configuration	5-15P	5-15P	5-15P	5-15P	5-15P
Total Amp Draw	3.2	3.4	7.9	7.9	9.9

Specifications subject to change without notice.

* NLSP27-8 has (6) 1/6 size pans and (2) 1/9 size pans included



Revision Date: 07/15
©2015 Nor-Lake, Inc.
Printed in the USA
Part Number: 146621