

Mark 10 Corn Treat

Instruction Manual

Models: 2410E & 2411E







 **GOLD MEDAL**®



FUNFOOD EQUIPMENT AND SUPPLIES



Cincinnati, OH 45241-4807 USA



Safety Precautions

	 DANGER
	<p>Machine must be properly grounded to prevent electrical shock to personnel. Failure to do so could result in serious injury, or death.</p> <p>DO NOT immerse any part of this equipment in water.</p> <p>DO NOT use excessive water when cleaning.</p> <p>Keep cord and plug off the ground and away from moisture.</p> <p>Always unplug the equipment before cleaning or servicing.</p> <p style="text-align: right; font-size: small;">008_010914</p>

	 DANGER
	<p>Improper installation, adjustment, alteration, service, or maintenance can cause property damage, injury, or death. Any alterations to this equipment will void the warranty and may cause a dangerous condition. NEVER make alterations to this equipment. Read the Installation, Operating, and Maintenance Instructions thoroughly before installing, servicing, or operating this equipment. Make sure all machine switches are in the OFF position before plugging the equipment into the receptacle.</p> <p style="text-align: right; font-size: small;">014_010914</p>

	 WARNING
	<p>To avoid burns, DO NOT touch the kettle or any heated surface.</p> <p>DO NOT place or leave objects in contact with heated surfaces.</p> <p style="text-align: right; font-size: small;">013_010914</p>

	 WARNING
	<p>ALWAYS wear safety glasses when servicing this equipment.</p> <p style="text-align: right; font-size: small;">010_010914</p>

	 WARNING
	<p>No user serviceable parts inside. Refer servicing to qualified service personnel.</p> <p style="text-align: right; font-size: small;">011_010914</p>

	 WARNING
	<p>Read and understand operator's manual and all other safety instructions before using this equipment. To order copies of the operator's manual go to gmpopcorn.com or write to Gold Medal Products Co., 10700 Medallion Drive, Cincinnati, OH 45241 USA 1-(800)-543-0862</p> <p style="text-align: right; font-size: small;">022_010914</p>

Safety Precautions (continued)

	⚠ WARNING
	<p>DO NOT allow direct contact of this equipment by the public when used in food service locations. Only personnel trained and experienced in the equipment operation may operate this equipment.</p> <p>Carefully read all instructions before operation.</p> <p style="text-align: right; font-size: small;">012_010914</p>

	⚠ WARNING
	<p>This machine is NOT to be operated by minors.</p> <p style="text-align: right; font-size: small;">007_010914</p>

Note: Improvements are always being made to Gold Medal's equipment. This information may not be the latest available for your purposes. It is critical that you call Gold Medal's Technical Service Department at 1-800-543-0862 for any questions about your machine operations, replacement parts, or any service questions. (Gold Medal Products Co. does not assume any liability for injury due to careless handling and/or reckless operation of this equipment.)

Mark 10 and 2622 Rolling Truck

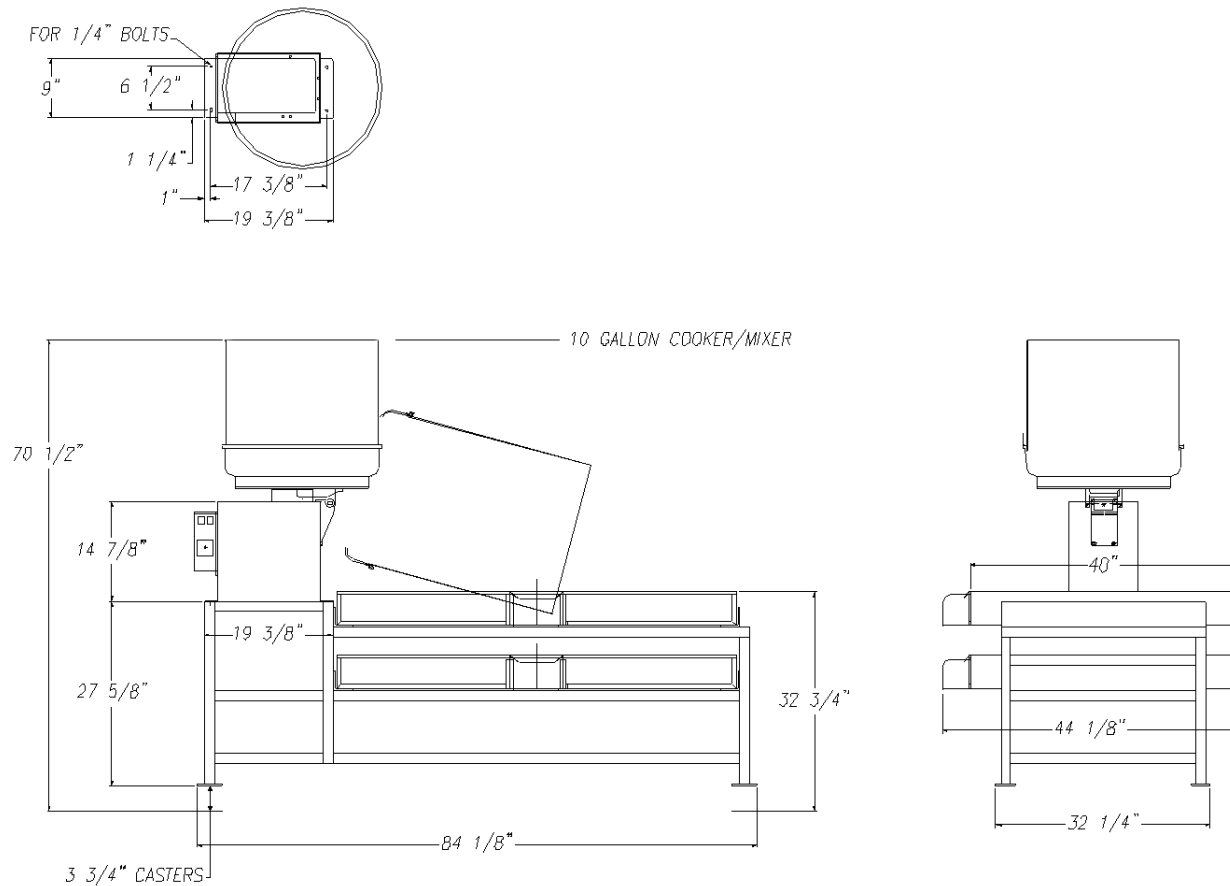

Left Hand Mark 10 (2411E) on 2622 truck shown

Electrical Specifications:

- Mark 10 (2410E - RH, 2411E - LH) - 120/208v or 120/230v 4 wire (2 hot, 1 neutral, 1 ground) 60 Hz.
5520 watts 30 amp plug & receptacle (NEMA L14-30P & L14-30R)
- Mark 10 (2410XE - RH, 2411XE - LH) -230v 50 Hz.

Other Dimensions:

- As shown.
- 40' x 60" Cooling Pan should be located approximately 3-5" below the Corn Treat Mixer Base

Model 2622 (Rolling Table)

- Includes Casters
- Includes (1) cooling pan (order p/n 48845 for extra cooling pan)

Gold Medal Products Co.
10700 Medallion Drive
Cincinnati, Ohio 45241-4807
Phone: 513-769-7676 fax: 513-769-8500
e-mail: www.gmpopcorn.com

INSTALLATION

	⚠ DANGER
	<p>Machine must be properly grounded to prevent shock in case of electrical problems.</p>
	<p>Wall receptacle must be wired as shown on the receptacle. Failure to wire properly will void the warranty and can result in damage to motors, elements, relay, lights, etc.</p>

CHECKING SHIPMENT

Unpack the shipping crate and check thoroughly for any damage which may have occurred in transit. Any claims should be filed immediately with the transportation company.

ELECTRICAL REQUIREMENTS

Voltage for the 2410E AND 2411E is 208 volt, 3-WIRE (2 HOT, 1 NEUTRAL) 60 cycle single phase. A wall receptacle is supplied with the machine. This receptacle will accept the attachment plug on your machine and must be used. The machine will draw a maximum of 23 amps. Your electrician must furnish sufficient current for the proper operation of your machine. We recommend that this machine be fused on a line by itself.

COUNTER MOUNTING REQUIREMENTS/INSTRUCTIONS

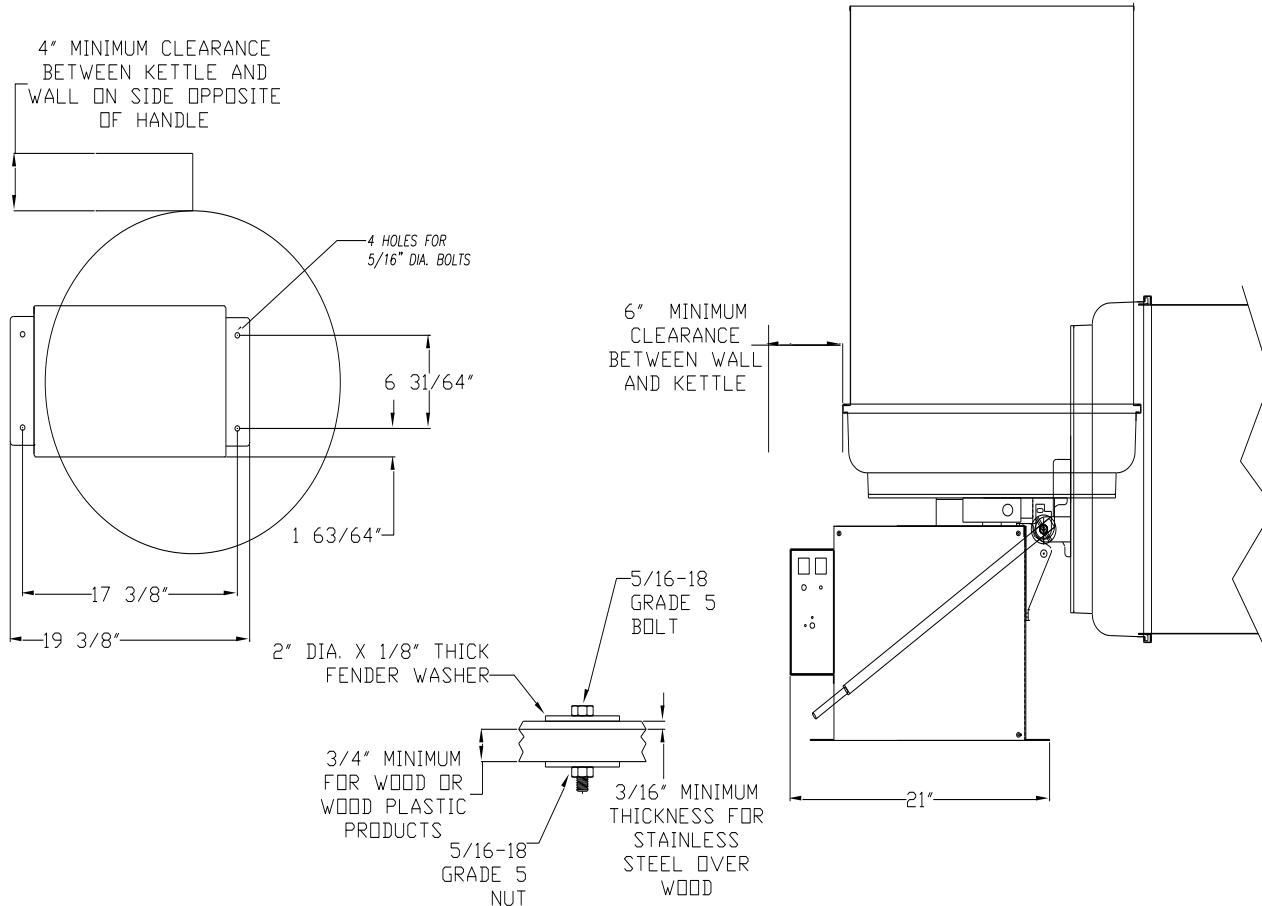

COUNTER MOUNTING REQUIREMENTS

CONTROLS AND THEIR FUNCTION

HEAT/MOTOR SWITCH

This rocker switch in the "ON" position energizes the heating elements in the bottom of the kettle, and also operates the motor for 15 seconds out of every minute.

MOTOR ONLY SWITCH

With this rocker switch in the "ON" position, the agitator motor will run continuously.

Note: The main function of this switch is for mixing the product/popcorn at the end of the cooking cycle with the kettle in the tilt position. It is also used for "cleaning mode".

HEAT CONTROL

The machine comes from the factory preset at 280°F. If more or less heat is required, remove the silver hole plug or cover plate, located on the front panel of the control box. This will allow you to access the heat control adjustment potentiometer. Turn the potentiometer clockwise to increase the temperature, and counter-clockwise to decrease.

To calibrate the heat control for corn treat, Fill the mixing bowl with a one inch depth of corn oil. Use an accurate thermometer to measure the temperature of the oil in the mixing bowl. Turn the motor on to stir the oil while it heats. When the oil reaches 280°F slowly turn the potentiometer counter clockwise until the buzzer sounds. If the buzzer sounds before the temperature reaches 280°F, slowly turn the potentiometer clockwise until the buzzer stops and continue to turn an additional 1/8 of turn.

Note: The sound of the buzzer always signals temperature cut-off.

Making Carmel Corn

Instructions for Making Carmel Corn (Mark 10)



Always remember to leave the lid on the kettle during the first part of the batch. Once steam starts to “roll-up” from underneath the lid, then carefully remove the lid for the remainder of the cooking cycle.

CAUTION: Beware of rising steam, and make sure to keep face and hands clear of the rising steam.

1. Turn the Heat/Motor Switch ON (do not turn on the Motor Only Switch).
2. Add (2) 22 ounce packages of Gold Medal Caramel Corn Mix (Item No. 2094), 8 cups of granulated sugar (brown or white), and 16-22 ounces of water (add water last).
Note: When using the Gold Medal “One Step” Carmel Corn Mix, DO NOT add granulated sugar.
3. Turn the Motor Only Switch ON and mix for approximately one minute, then turn the Motor Only Switch OFF. (With the Heat/Motor Switch ON, the motor will run for 30 seconds every minute.)
4. Add 2 sticks (8 ounces) of coconut oil or vegetable oil.
5. Allow the mix to cook until the buzzer sounds at 280°F product temperature.
6. Turn the Heat/Motor Switch OFF.
7. Turn the Motor Only Switch ON.
8. Add 10 gallons of pre-popped corn.
9. Allow the corn to mix for approximately 10 seconds with the kettle in the upright position.
10. Move the kettle to the mix position and spray 10-15 “squirts” of GOLD Medal Free-N-Easy (Item No. 2250) for proper corn separation, and mix the popcorn until it is thoroughly coated.
11. Dump the caramel corn into the cooling pan, and mix/separate the caramel corn using two popcorn scoops.
12. After dumping caramel corn, turn Motor Only Switch OFF.
13. Allow the finished product to cool before packaging.

During normal operation, sugar build-up will occur in the cooking area. This build-up must be removed by steaming out the kettle every 3-4 batches. It is important that this is done, especially before the machine is turned off for the day. If making single batches, with the machine turned off between batches, the kettle must be steamed out after each batch has been completed. Follow the Proper Kettle Cleaning Procedure in the Care and Cleaning section of this manual.

Care and Cleaning

	 DANGER
	<p>Machine must be properly grounded to prevent electrical shock to personnel. DO NOT immerse in water. Always unplug the equipment before cleaning or servicing.</p> <p style="text-align: right; font-size: small;">025_020314</p>

	 WARNING
	<p>To avoid serious burns, DO NOT touch the kettle while it is hot!</p> <p style="text-align: right; font-size: small;">028_020314</p>

Good sanitation practice demands that all food preparation equipment be cleaned regularly (only use non-toxic, food grade cleaners). A clean looking, well-kept machine is one of the best ways of advertising your product.

Corn Treat Cleaning Instructions

Note: It is extremely important to follow all of the cleaning procedures, otherwise parts damage and equipment failure will result. The warranty does not cover parts that are damaged due to improper cleaning.

Proper Kettle Cleaning Procedure

Follow the procedure below to steam the sugar build-up out of the kettle every 3-4 batches during regular operation and before the machine is turned off for the day. The kettle must also be steamed out after making single batches, if the machine is turned off between batches.

1. After all product has been removed, and the kettle has cooled for 15-20 minutes, carefully pour 24 oz. of water into the kettle.
CAUTION: Beware of rising steam; make sure to keep face and hands clear of the rising steam.
2. Place the lid on the kettle, and turn the Heat/Motor Switch ON.
3. When water starts to boil, turn Heat/Motor Switch OFF.
4. Turn the Motor Switch ON; allow the machine to cool, then remove the lid and carefully pour the contents of the kettle into a pan or bucket. Steam the kettle twice to remove all traces of product.
5. Turn the Motor Switch OFF.
6. With all switches OFF, wipe out any excess sugar build-up from the kettle using a damp rag, then the kettle is ready to begin another batch.
7. Do not leave water in the pans overnight.

Daily Unit Cleaning Procedure

Follow the directions below to clean and sanitize the unit each day after use.

1. With the machine OFF, unplug the unit and allow it to cool before attempting to clean.
2. Make sure to clean all pans/accessories in order to sanitize them before each use.

3. Release the draw latch to easily remove the mixing drum, then remove paddles. The mixing drum and paddles can be taken to the sink to clean.
4. Wipe the kettle lead cord with a clean **SLIGHTLY** damp cloth. **DO NOT get moisture into the kettle lead-in cord, severe damage will result.**
5. The cabinet of your machine should be wiped clean daily (or more, depending on usage) with a clean soft cloth, SLIGHTLY dampened with soap and hot water.

Wipe the stainless steel parts with a clean cloth and cleaner designed for stainless steel, such as Gold Medal Watchdog Stainless Cleaner (Item No. 2088).



DO NOT use oven cleaners or abrasive materials as they will damage parts of the machine.

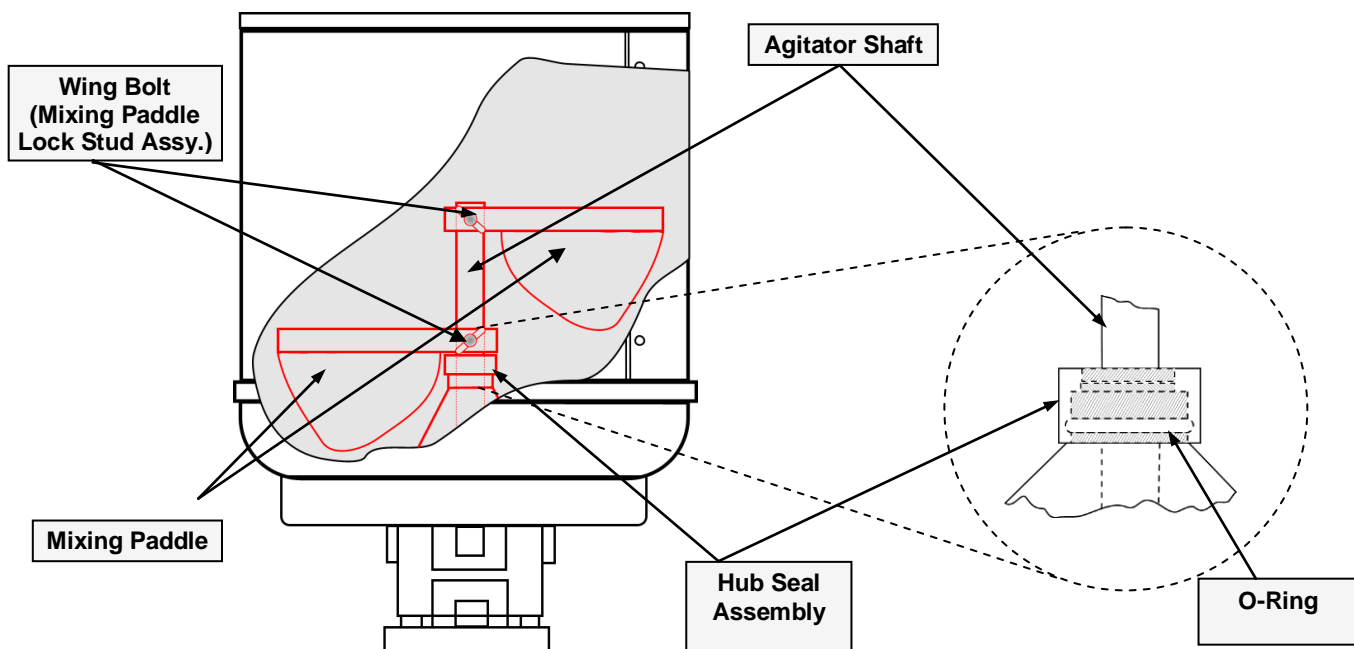

Proper Hub Seal Assembly Cleaning Procedure

1. Unscrew the wing bolt (Mixing Paddle Lock Stud Assy.) and remove the mix paddles.
2. Remove any burrs on the shaft using a fine grit emery paper to lightly sand the surface. If the burrs are not removed, damage may occur to the o-ring/oil seal during removal/installation.
3. Remove the hub seal assembly and soak it in hot water to clean.
4. Clean the area around the center hub. Remove any product residue. (Units manufactured prior to Jan. 2014, see Kettle Shaft Maintenance section for note on lubricating kettle bushings.)
5. Lightly lubricate the center hub of the kettle with a small amount of vegetable oil to allow for easy installation of the hub seal assembly.
6. Slide the clean hub seal assembly down the agitator shaft. Apply pressure to ease the assembly over the center hub of the kettle until it seats properly (see diagram below.)
7. Slide the hub seal assembly down the agitator shaft. Apply pressure to ease the assembly over the center hub of the kettle until it seats properly. (See diagram below.)
8. After the hub seal assembly has been properly installed, re-install the mix paddles onto the agitator shaft.
9. Replace the wing bolts and finger tighten.





MAINTENANCE INSTRUCTIONS

	 DANGER
	<p>Machine must be properly grounded to prevent electrical shock to personnel. Failure to do so could result in serious injury, or death.</p> <p>DO NOT immerse any part of this equipment in water.</p> <p>DO NOT use excessive water when cleaning.</p> <p>Keep cord and plug off the ground and away from moisture.</p> <p>Always unplug the equipment before cleaning or servicing.</p> <p>Make sure all machine switches are in the OFF position before plugging the equipment into the receptacle.</p> <p style="text-align: right;">008_051514</p>

	 DANGER
	<p>Improper installation, adjustment, alteration, service, or maintenance can cause property damage, injury, or death. Any alterations to this equipment will void the warranty and may cause a dangerous condition. NEVER make alterations to this equipment. Read the Installation, Operating, and Maintenance Instructions thoroughly before installing, servicing, or operating this equipment.</p> <p style="text-align: right;">014_051514</p>

	 WARNING
	<p>No user serviceable parts inside. Refer servicing to qualified service personnel.</p> <p style="text-align: right;">011_051514</p>

	 CAUTION
	<p>THE FOLLOWING SECTIONS OF THIS MANUAL ARE INTENDED ONLY FOR QUALIFIED SERVICE PERSONNEL WHO ARE FAMILIAR WITH ELECTRICAL EQUIPMENT. THESE ARE NOT INTENDED FOR THE OPERATOR.</p> <p style="text-align: right;">027_010914</p>

NEW PADDLE & HUB SEAL KIT INSTALLATION and Kettle Shaft Maintenance

1. Unscrew the wing bolt (Mixing Paddle Lock Stud Assy.) and remove the mix paddles.
2. Remove the old hub seal assembly.
3. Clean the area around the center hub. Clean up all food and carbon residue.

Note: For units manufactured prior to Jan. 1, 2014 only (kettle bushings have an o-ring groove and o-ring). For these units, the kettle's agitator shaft should be removed monthly and the bushings lubricated with Never Seez® (use White Food Grade **ONLY**). To do this, loosen the set screw in the Jaw Coupling and remove the shaft. **DO NOT lose the shaft key; this must be reset into place when reassembling.**

4. Remove any burrs on the top edge of the center hub. Use a fine grit emery paper to lightly sand the surface. If the burrs are not removed, damage may occur to the hub assembly during installation.
5. Lightly lubricate the center hub of the kettle with a small amount of vegetable oil to allow for easy installation of the hub seal assembly.
6. Slide the hub seal assembly down the agitator shaft. Apply pressure to ease the assembly over the center hub of the kettle until it seats properly. (See diagram below.)
7. After the hub seal assembly has been properly installed, place the new mix paddles on the top of the agitator shaft.
8. Replace the wing bolts and finger tighten.

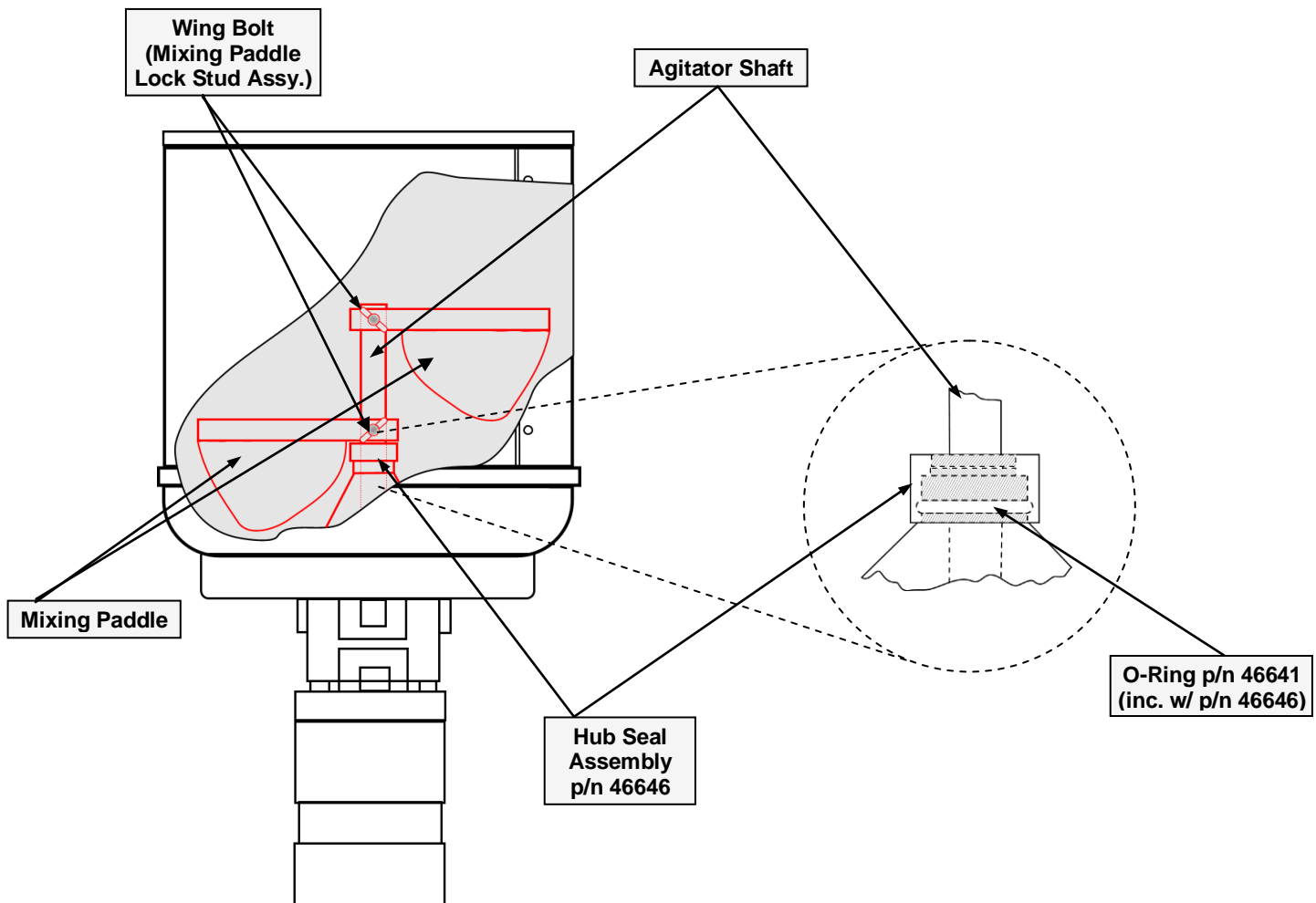

ORDERING SPARE PARTS

1. Identify the needed part by checking it against the photos, illustrations, and/or the parts list.
2. When ordering, please include part number, part name, and quantity needed.
3. Please include your model name, serial number, and date of manufacture (located on the machine nameplate) with your order.
4. Address all parts orders to:

Parts Department
Gold Medal Products Co.
10700 Medallion Drive
Cincinnati, Ohio 45241-4807

or, place orders at:

(800) 543-0862

(513) 769-7676

Fax: (513) 769-8500

E-mail: info@gmpopcorn.com

Web Page: www.gmpopcorn.com

Corn Treat System Controller

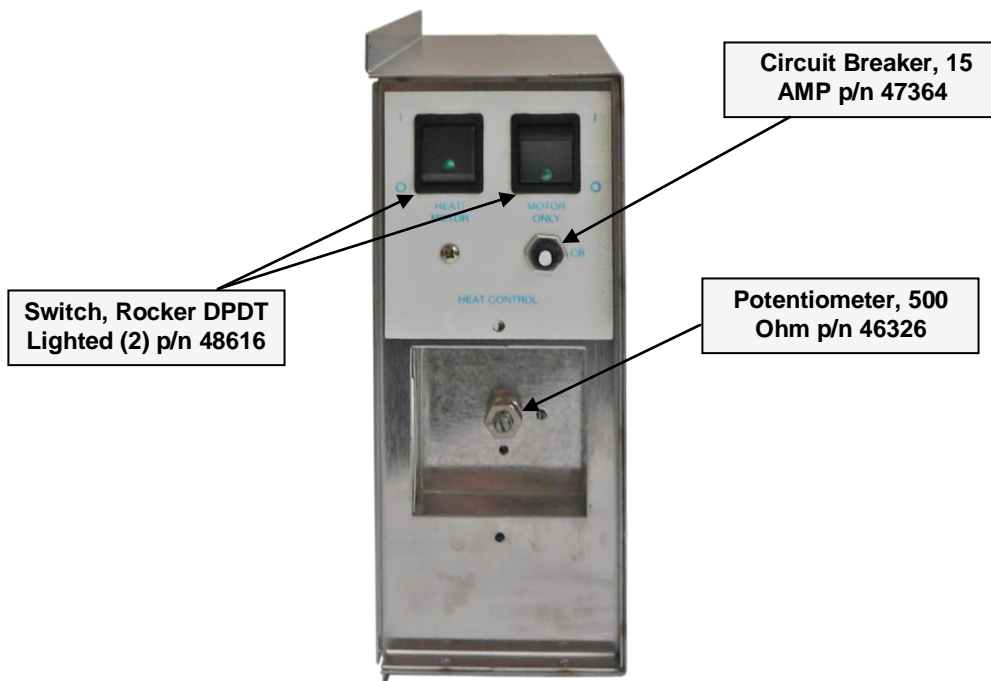
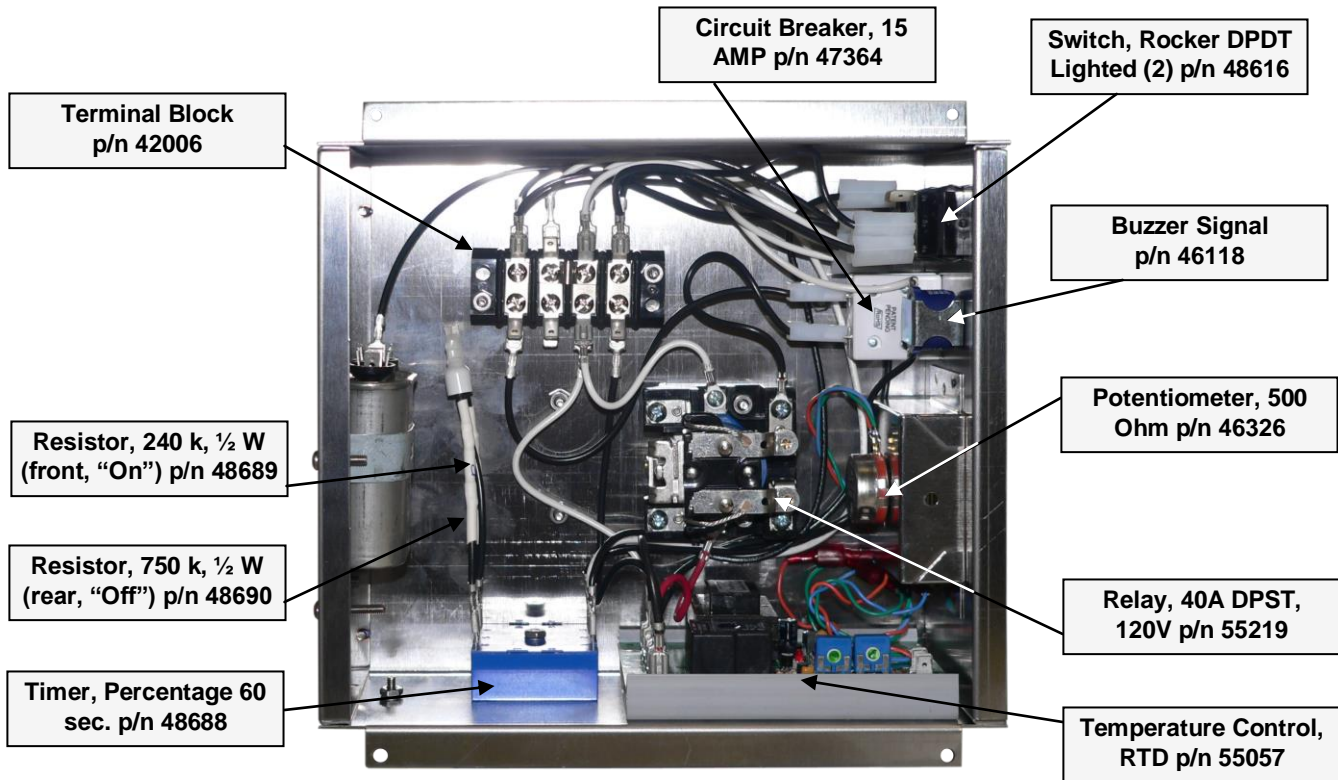

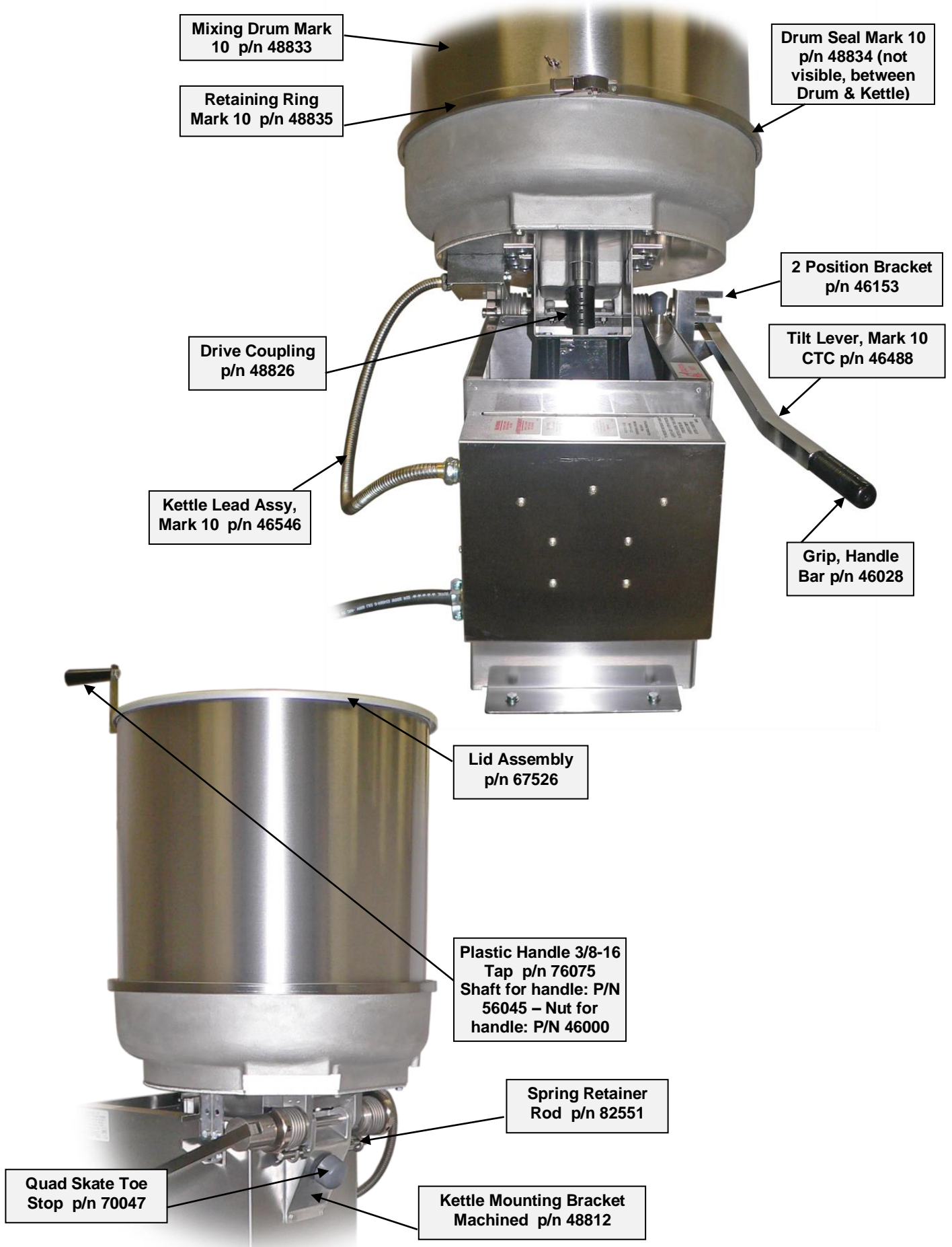

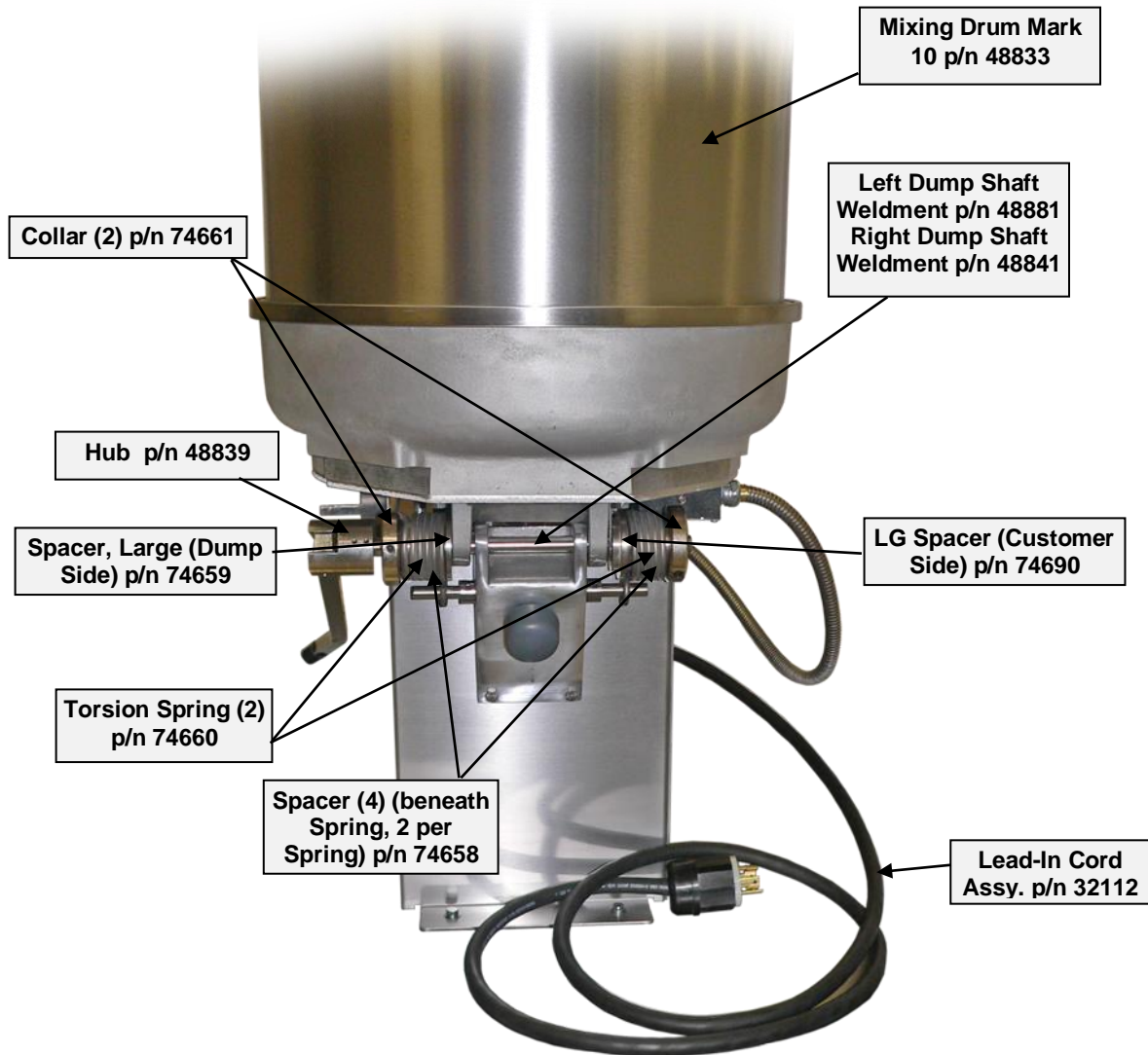

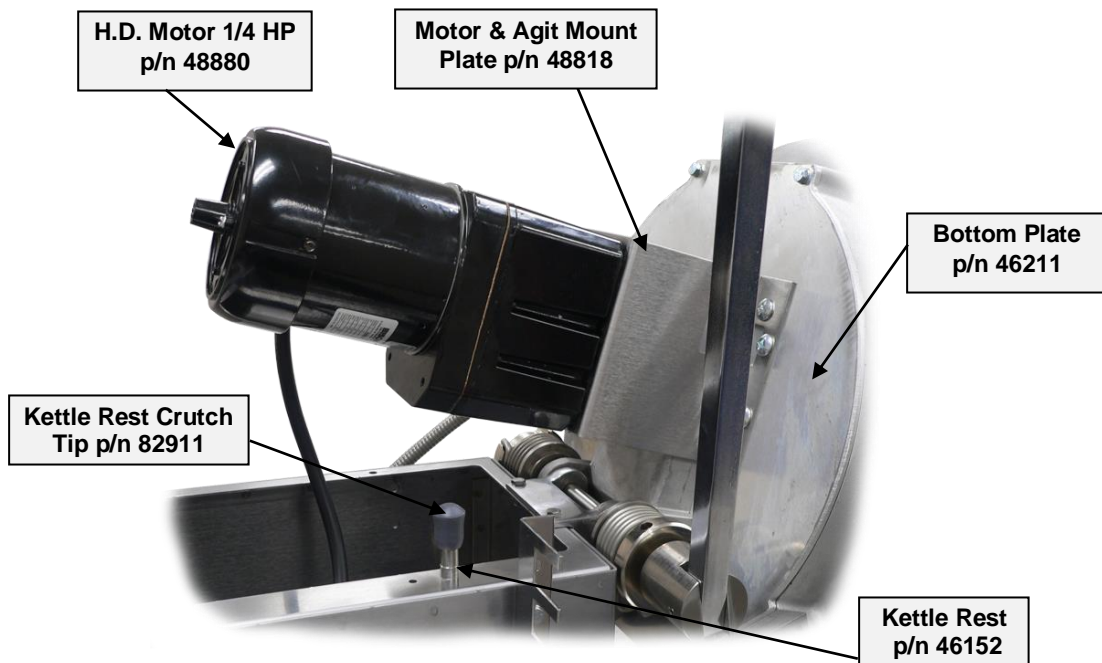
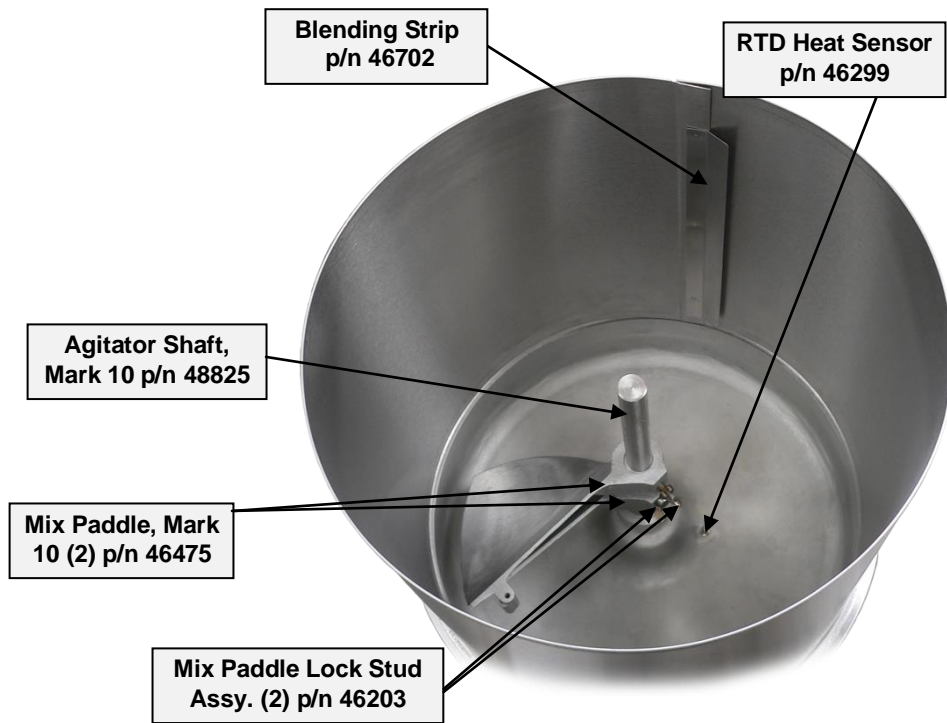

Kettle Bottom

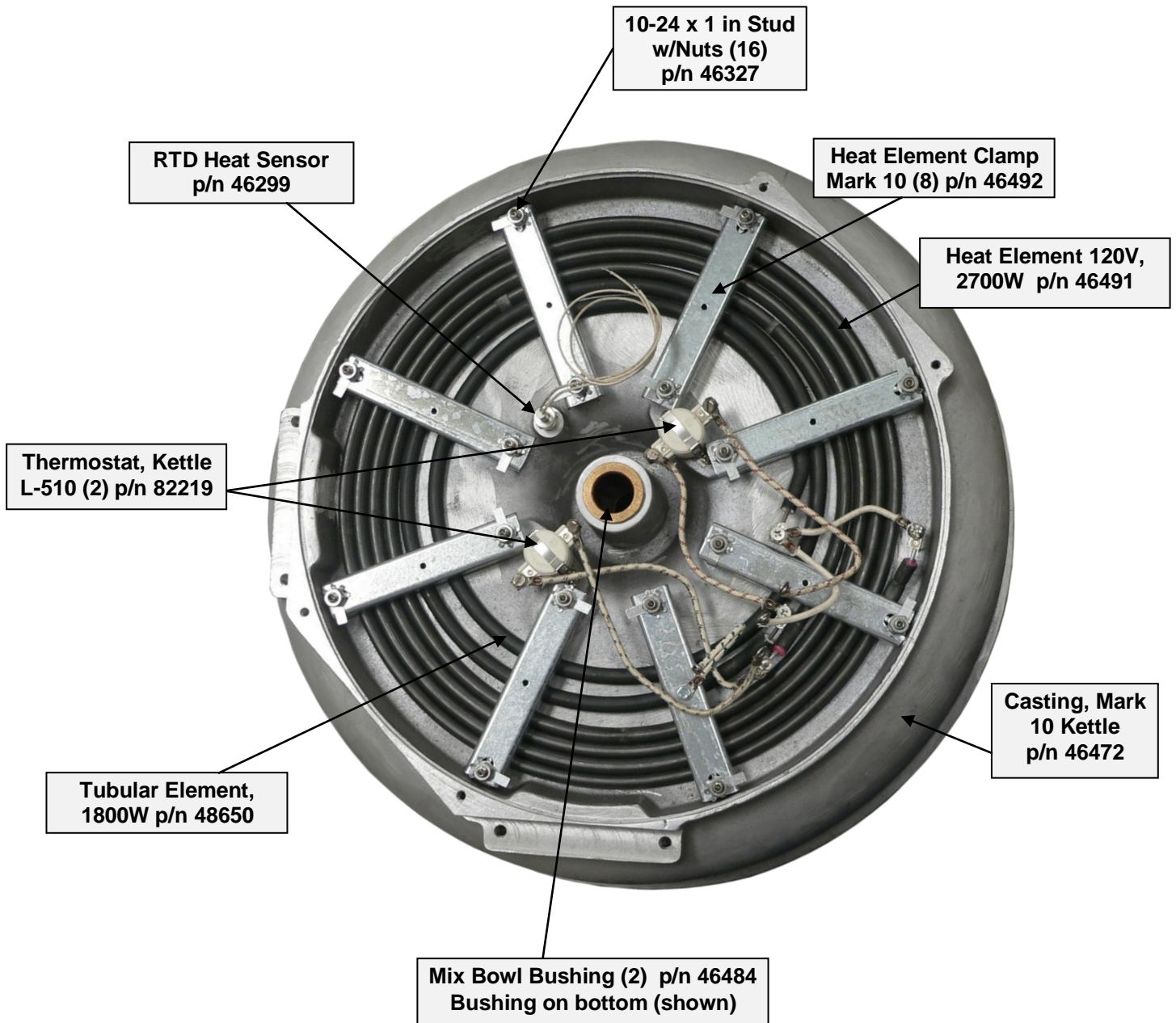

WARRANTY

Gold Medal Products Co. warrants to the original purchaser each item of its manufacture to be free of defects in workmanship and material under normal use and service. Gold Medal Products Co.'s obligation under this warranty is limited solely to repairing or replacing parts, f.o.b. Cincinnati, Ohio, which in its judgment are defective in workmanship or material and which are returned, freight prepaid, to its Cincinnati, Ohio factory or other designated point. Except for "Perishable Parts" on specific machines, the above warranty applies for a period of two (2) years from the date of original sale to the original purchaser of equipment when recommended operating instructions and maintenance procedures have been followed. These are packed with the machine. Parts warranty is two (2) years, labor is six (6) months.

THIS WARRANTY IS IN LIEU OF ALL OTHER WARRANTIES EXPRESSED OR IMPLIED, AND OF ALL OTHER OBLIGATIONS OR LIABILITIES ON OUR PART, INCLUDING THE IMPLIED WARRANTY OF MERCHANTABILITY. THERE ARE NO WARRANTIES WHICH EXTEND BEYOND THE DESCRIPTION ON THE FACE HEREOF. In no event shall Gold Medal Products Co. be liable for special, incidental or consequential damages. No claim under this warranty will be honored if the equipment covered has been misused, neglected, damaged in transit, or has been tampered with or changed in any way. No claim under this warranty shall be honored in the event that components in the unit at the time of the claim were not supplied or approved by Gold Medal Products Co. This warranty is effective only when electrical items have been properly attached to city utility lines only at proper voltages. This warranty is not transferable without the written consent of Gold Medal Products Co.

The term "Original Purchaser" as used in this warranty shall be deemed to mean that person, firm, association, or corporation who was billed by the GOLD MEDAL PRODUCTS CO., or their authorized distributor for the equipment.

THIS WARRANTY HAS NO EFFECT AND IS VOID UNLESS THE ORIGINAL PURCHASER FIRST CALLS GOLD MEDAL PRODUCTS CO. AT 1-800-543-0862 TO DISCUSS WITH OUR SERVICE REPRESENTATIVE THE EQUIPMENT PROBLEM, AND, IF NECESSARY, FOR INSTRUCTIONS CONCERNING THE REPAIR OR REPLACEMENT OF PARTS.

NOTE: This equipment is manufactured and sold for commercial use only.



GOLD MEDAL[®] PRODUCTS CO.

10700 Medallion Drive, Cincinnati, Ohio 45241-4807 USA

gmpopcorn.com

Phone: (800) 543-0862 Fax: (800) 542-1496
(513) 769-7676 (513) 769-8500

© 2014 – The text, descriptions, graphics, layout, and other material in this publication are the exclusive property of Gold Medal Products Co. and shall not be used, copied, reproduced, or published in any fashion, including website display, without its express written consent.