





Passion, Commitment and Quality Personified

DYNAMIC, the inventor of the Immersion Blender and Commercial Salad Spinner is proud to celebrate our 58th year manufacturing quality equipment and supplies for the foodservice industry.

DYNAMIC invented the commercial immersion blender in 1964 and the commercial salad spinner in 1992. In 2000 we introduced the manual dicer and in 2014 relaunched the Power Pro mobile mixer. The MiniPro immersion blender has been the #1 commercial hand mixer in the world for the last 10 years!

DYNAMIC designs and manufactures the widest range of commercial immersion blenders on the market and offers the best in versatility with an extensive range of

accessories. All our machines and motors are designed and manufactured in our facilities in France with the best available materials to ensure strong and reliable products of the highest quality.

DYNAMIC is constantly innovating and improving product lines to best serve our customers' needs and continuously establish ourselves as leaders in the industry. We are dedicated to the foodservice industry and chefs all around the world.

DYNAMIC has all spare parts available and offers strong and responsive customer service with close follow-up to provide the best possible after-sales service.



N°1 MANUAL DICER IN THE WORLD



Demo Video

DYNACUBE



SEE PAGE 25

MINI SERIES

P8-9

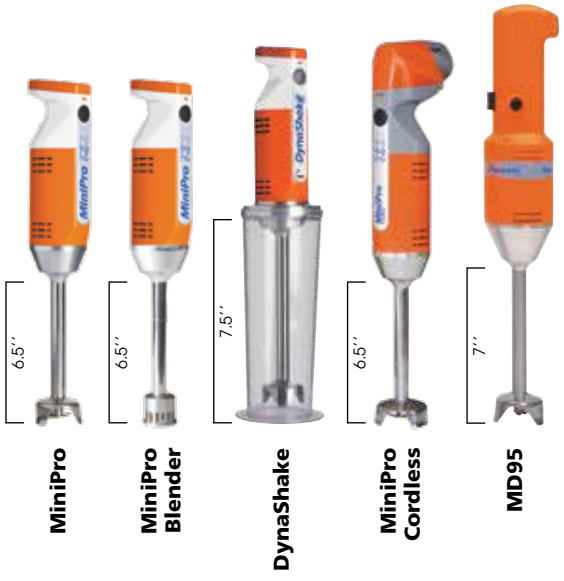

JUNIOR SERIES

P10-11

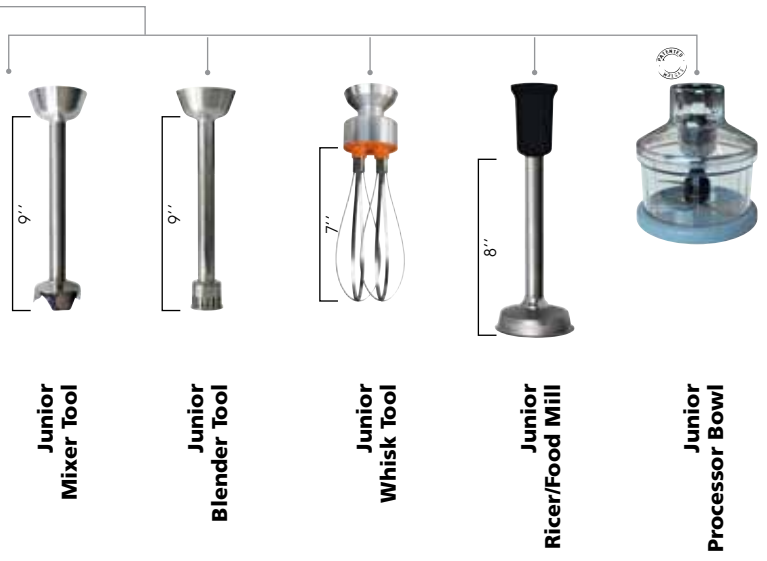
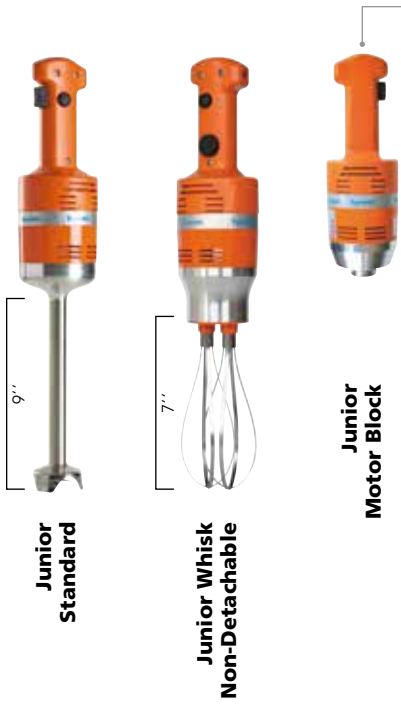

SENIOR SERIES

P12-13

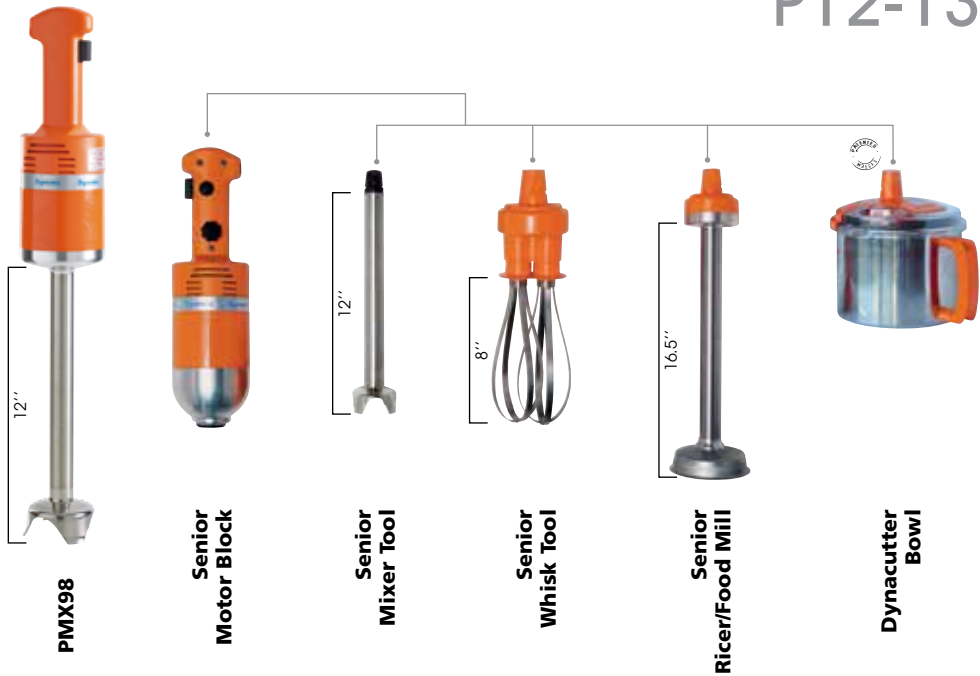

MASTER SERIES

P14-15

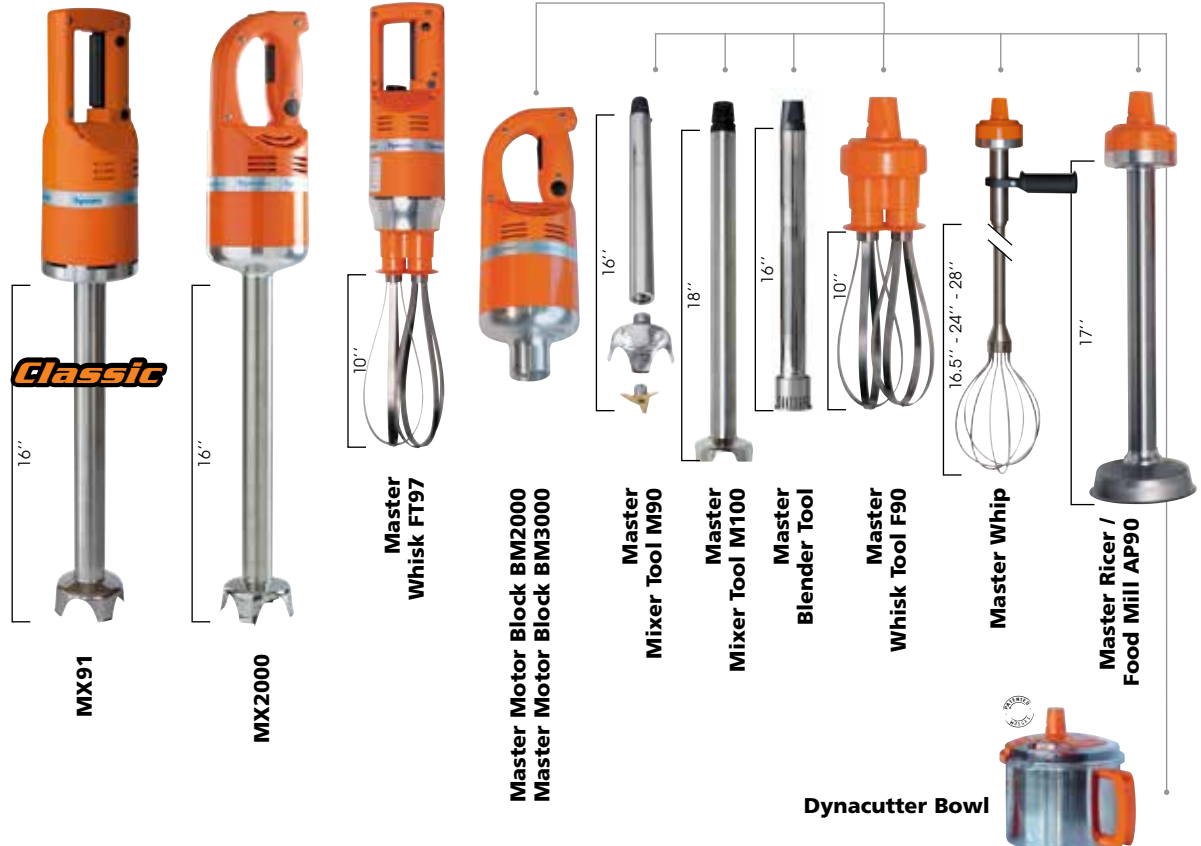

HEAVY DUTY SMX SERIES P16-17

10 GAL 40 L	20 GAL 75 L	30 GAL 115 L	40 GAL 150 L	50 GAL 200 L	60 GAL 225 L	75 GAL 300 L
SMX250ES	SMX350ES	SMX450ES	SMX550ES	SMX650ES	SMX750ES	SMX850ES

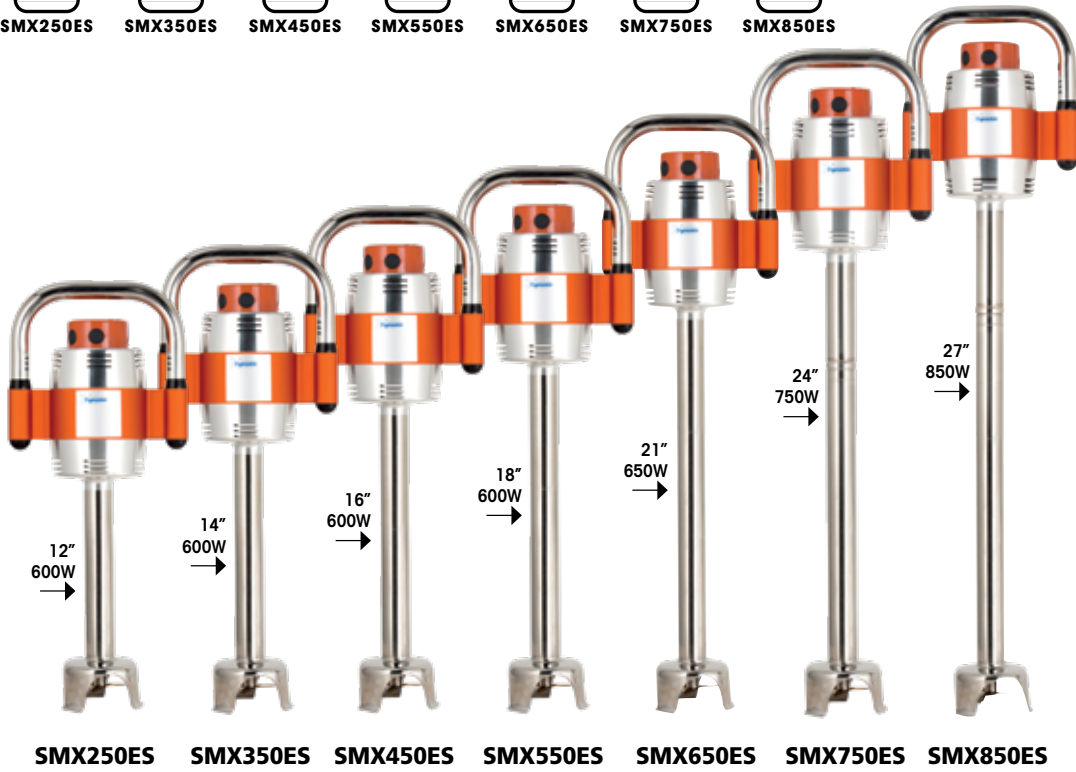

TOP-MOUNTED
SUPPORT BRACKETS



SIDE-MOUNTED
SUPPORT BRACKETS



SMX BLENDER TOOL



SMX MIXER TOOL

MOBILE MIXER

P18-19

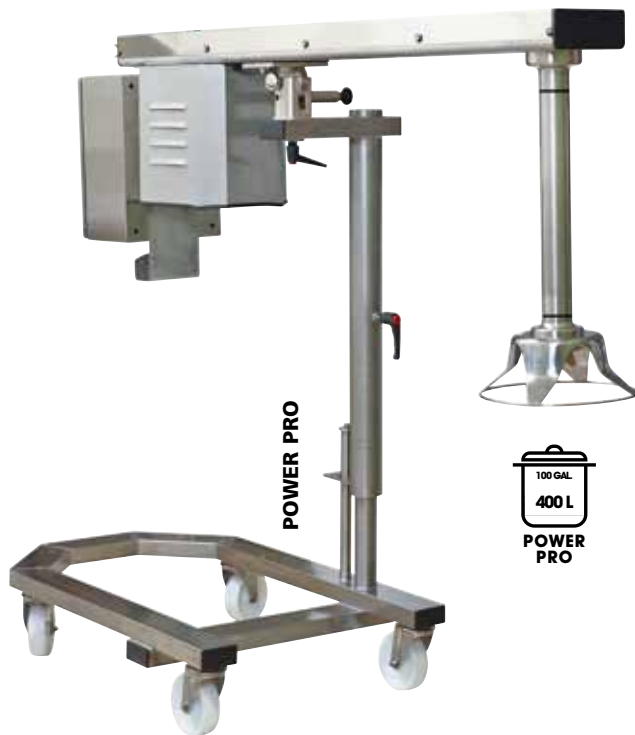

BLENDER SERIES

P20-21



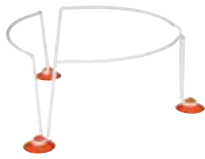

SSB1
Stabilizing Base

* FOR SD92, SD92SC AND EM98



SALAD SPINNERS P22-23



SD MINI Sealed Cover Manual

SD99 Manual

SD92 / SD92SC Manual



SD92 / SD92SC Manual with stabilizing base

EM98 Electric

CITRUS JUICER P24



PA96

RICER/ FOOD MILL P24



PP97 Ricer/Food Mill

PP97 PLUS

FM97 Whisk Tool

20.5"

22.5"

27"



FOODMILL RICER TOOL

WHISK

DYNACUBE MANUAL DICER P25



N°1 MANUAL DICER IN THE WORLD

MINI SERIES

DETACHABLE
200 W
1 TO 8 L



Variable
speed

OFFERED IN
6 COLORS

MX070.11

MX070.12

MX070.13

MX070.14

MX070.15



160 mm / 6.5"



Variable
speed

NEW



160 mm / 6.5"



160 mm / 6.5"

MiniPro

Reference	MX070.1
Total length	395 mm / 15,5"
Mixer tool length	160 mm / 6,5"
Diameter	70 mm / 2,8"
Actual weight	1,1 Kg / 2,5 lbs
Shipping weight	1,5 Kg / 3,2 lbs
Output	200 W
Speed	0 to 13 000 R.P.M.

MiniPro Blender

Reference	MX069.1
Total length	395 mm / 15,5"
Mixer tool length	160 mm / 6,5"
Diameter	70 mm / 2,8"
Actual weight	1,1 Kg / 2,5 lbs
Shipping weight	1,5 Kg / 3,2 lbs
Output	200 W
Speed	0 to 13 000 R.P.M.

MiniPro Cordless

Reference	MX135.1
Total length	450 mm / 17,7"
Mixer tool length	160 mm / 6,5"
Diameter	70 mm / 2,8"
Actual weight	1,1 Kg / 2,4 lbs
Shipping weight	1,9 Kg / 4,2 lbs
Output	2000 mAh - 12 Vdc
Speed	10 000 R.P.M.

MiniPro comes with 4 blades :



Emulsifying
0550



Standard
0551



Batter Disc
0552



Dairy Disc
0553

MiniPro Cordless comes complete with :

2 Batteries (AC585 - 20 minutes run-time)

1 Charger (AC590.1 - 45 minutes charge time / battery)



Variable speed



160 mm / 6.5"



Variable speed



190 mm / 7.5"

MD95 / MD95E

Total length	445 mm / 17,5"
Mixer tool length	160 mm / 6.5"
Diameter	72 mm / 3"
Actual weight	1,2 Kg / 2,6 lbs
Shipping weight	1,5 Kg / 3,3 lbs
Output	180 W
Speed	9 500 R.P.M.

MD95 with variable speed

Reference	MX010.1.V
Speed	0 to 9 500 R.P.M.

MD95 (MX010.1)
with standard blade

MD95E (MX008.1)
with emulsifying blade



Emulsifying
9414

Dynashake

Reference	MX054.1
Total length	425 mm / 16,7"
Mixer tool length	190 mm / 7,5"
Diameter	95 mm / 3,8"
Actual weight	1,2 Kg / 2,7 lbs
Shipping weight	1,9 Kg / 4,2 lbs
Output	200 W
Speed	0 to 13 000 R.P.M.

Dynashake comes complete with: 1 Dynashake mixer, 1 emulsifying blade, 1 standard blade, 1 batter blade, 1 dairy blade, 1 litre graduated cup + lid

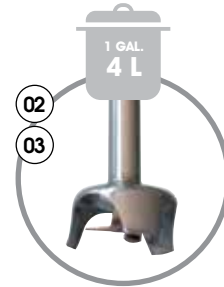

AC520 - 160 mm / 6.5"
AC530 - 190 mm / 7.5"

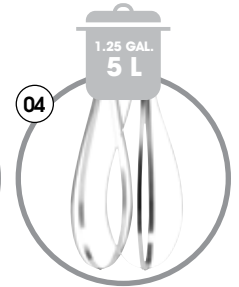

AC516 - 185 mm / 7"



AC560 - 190 mm / 7.5"

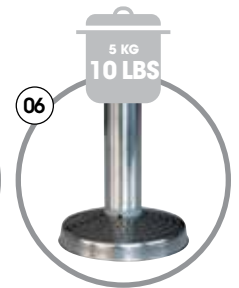

AC517 - 125 mm / 5"



AC518



AC510



AC513



SM030

01 - MiniPro motor block

Reference	AC515.1
Total length	205 mm / 8"
Diameter	70 mm / 2,8"
Actual weight	1 Kg / 2,1 lbs
Shipping weight	1,3 Kg / 2,8 lbs
Output	200 W
Speed	0 to 13 000 R.P.M.

- 02 - MiniPro mixer tool with standard blade
- 03 - Dynashake mixer tool with standard blade
- 04 - MiniPro whisk tool
- 05 - MiniPro blender tool
- 06 - MiniPro ricer / food mill
- 07 - MiniPro food processor bowl
- 08 - Dynashake graduated cup with lid
- 09 - MiniPro stainless steel cup
- 10 - MiniPro stand

JUNIOR SERIES



NON-DETACHABLE /
DETACHABLE

270 W

1 TO 25 L



Option
variable
speed



225 mm / 9"



Variable
speed



185 mm / 7"

Junior Standard non-detachable

Reference	MX020.1
Total length	505 mm / 20"
Mixer tool length	225 mm / 9"
Diameter	94 mm / 4"
Actual weight	1,7 Kg / 3,7 lbs
Shipping weight	2,0 Kg / 4,4 lbs
Output	250 W
Speed	9 500 R.P.M.

Junior Standard non-detachable with variable speed

Reference	MX020.1.V
Speed	0 to 9 500 R.P.M.



Ref. 089959
Wall support included

Junior Whisk non-detachable

Reference	FT005.1
Total length	500 mm / 20"
Whisk length	185 mm / 7"
Diameter	94 mm / 4"
Actual weight	1,4 Kg / 3 lbs
Shipping weight	1,7 Kg / 3,7 lbs
Output	200 W
Speed	0 to 2 000 R.P.M.



Ref. 0880.1
Convenient and secure :
Wall storage bracket for mixer
and accessories included with
Junior Whisk and motor block.



Variable speed

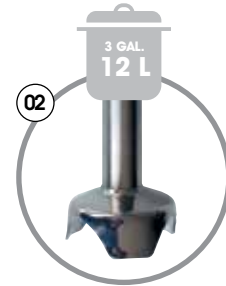

AC101 - 225 mm / 9"



AC066 - 225 mm / 9"

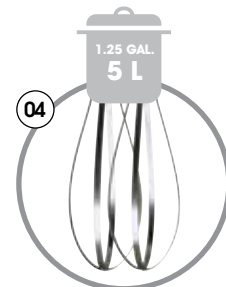

AC102 - 185 mm / 7"

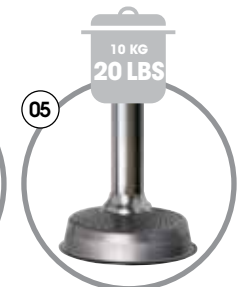

AC103 - 200 mm / 8"



AC104

01 - Junior motor block

Reference	AC100.1
Total length	305 mm / 12"
Diameter	94 mm / 4"
Actual weight	1,9 Kg / 4 lbs
Shipping weight	2,3 Kg / 5 lbs
Output	250 W
Speed	0 to 9 500 R.P.M.

- 01 - Junior motor block
- 02 - Junior mixer tool
- 03 - Junior blender tool
- 04 - Junior whisk tool
- 05 - Junior ricer / food mill
- 06 - Junior processor bowl

SENIOR SERIES

NON-DETACHABLE /
DETACHABLE

300 W

20 TO 40 L



Option
variable
speed



PMX98 Standard non-detachable

Reference	MX007.1
Total length	600 mm / 24"
Mixer tool length	300 mm / 12"
Diameter	97 mm / 4"
Actual weight	2,4 Kg / 5,3 lbs
Shipping weight	2,9 Kg / 6,4 lbs
Output	300 W
Speed	9 500 R.P.M.

PMX98 Standard non-detachable with variable speed

Reference	MX007.1.V
Speed	0 to 9 500 R.P.M.

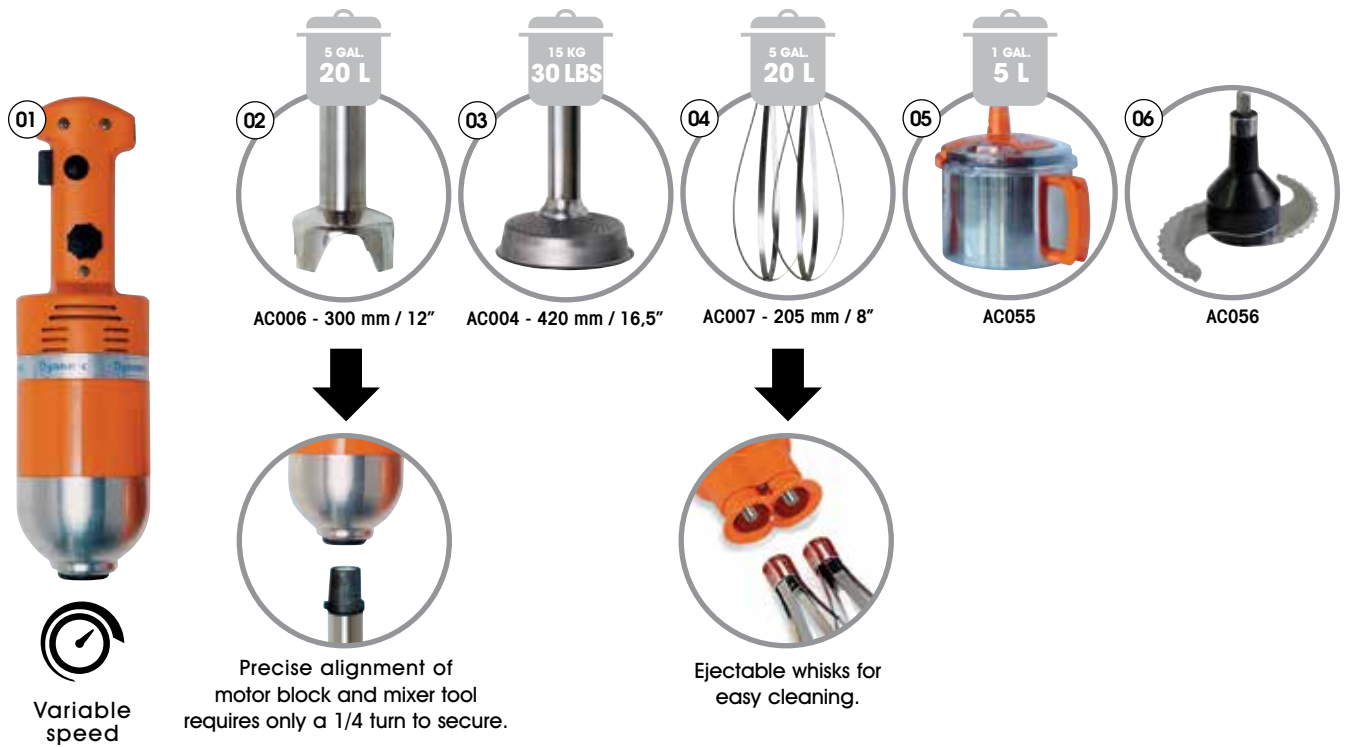

Precise alignment of motor block and mixer tool requires only a 1/4 turn to secure.

Ejectable whisks for easy cleaning.



Ref. 0880
Convenient and secure :
 Wall storage bracket for mixer and accessories included with Senior motor block.



01 - Senior motor block BM250

Reference	AC005.1
Total length	330 mm / 13"
Diameter	97 mm / 4"
Actual weight	2,0 Kg / 4,4 lbs
Shipping weight	3,1 Kg / 6,8 lbs
Output	300 W
Speed	0 to 9 500 R.P.M.

300 watts motor block can be used with the mixer tool and whisk attachment.

- 01 - Senior motor block
- 02 - Senior mixer tool M250
- 03 - Senior ricer / food mill
- 04 - Senior whisk F250
- 05 - Dynacutter bowl *
- 06 - Serrated blade for Dynacutter

* The complete Dynacutter bowl includes a 5 litre / 6 qt - bowl, cover, reducer and a standard blade or serrated blade.



MASTER SERIES

NON-DETACHABLE /
DETACHABLE
460 W
40 TO 100 L



Option
variable
speed



410 mm / 16"



Ref. 0881
Wall support included



Option
variable
speed



410 mm / 16"



Ref. 0862
Wall support included

MX91 *Classic* non-detachable

Reference	MX005.1
Total length	715 mm / 28"
Mixer tool length	410 mm / 16"
Diameter	110 mm / 4,5"
Actual weight	3,4 Kg / 7,5 lbs
Shipping weight	3,8 Kg / 8,4 lbs
Output	460 W
Speed	9 500 R.P.M.

MX91 Classic non-detachable with variable speed

Reference	MX005.1.V
Speed	0 to 9 500 R.P.M.



Emulsifying blade
7910

MX2000 non-detachable

Reference	MX004.1
Total length	720 mm / 28,5"
Mixer tool length	410 mm / 16"
Diameter	122 mm / 5"
Actual weight	3,5 Kg / 7,7 lbs
Shipping weight	4,1 Kg / 9 lbs
Output	460 W
Speed	9 500 R.P.M.

MX2000 non-detachable with variable speed

Reference	MX004.1.V
Speed	0 to 9 500 R.P.M.

Only available for the MX2000



Safety button



Continuous
function auto
run button also
allows to mix
continuously
by pulse.



Variable speed



245 mm / 10"



Variable speed



1A Master motor block BM2000

Reference	AC001.1
Output	460 W

1B Master motor block BM3000

Reference	AC001.1.A
Output	550 W

Total length	350 mm / 13,8"
Diameter	122 mm / 4,8"
Actual weight	2,7 Kg / 6,0 lbs
Speed	0 to 9 500 R.P.M.



SM020
Mixer weight support clamp included with Master motor blocks.

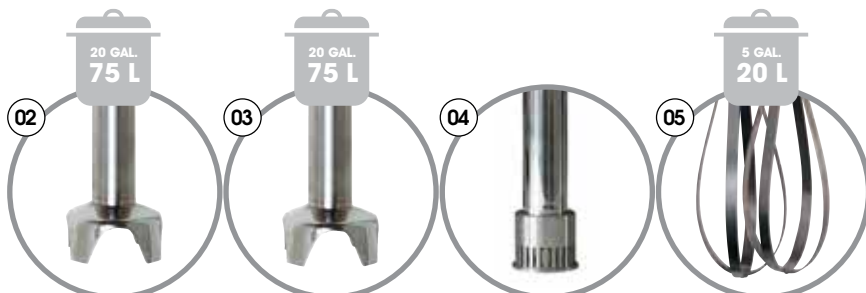

02 AC002 - 410 mm / 16"

03 AC500 - 457 mm / 18"

04 AC070 - 410 mm / 16"

05 AC003 - 245 mm / 10"



06 AC004 - 420 mm / 16.5"

07 AC055

08 AC056

09 10 11

FT97 Master Whisk non-detachable

Reference	FT001.1
Total length	650 mm / 25,5"
Whisk tool length	245 mm / 10"
Diameter	110 mm / 4,5"
Actual weight	3,3 Kg / 7,3 lbs
Shipping weight	3,7 Kg / 8,1 lbs
Output	460 W
Speed	0 to 900 R.P.M.

Ejectable whisks for easy cleaning



Ref. 0880
Convenient and secure :
Wall storage bracket for mixer and accessories included with Master motor blocks.

**Enhanced versatility!
Use up to 10 attachments with only 1 motor block.**

- 1A - Master motor block BM2000
- 1B - Master motor block BM3000
- 02 - Master mixer tool M90
- 03 - Master mixer tool M100
- 04 - Master blender tool
- 05 - Master whisk tool F90
- 06 - Master ricer / food mill AP90
- 07 - Dynacutter bowl *
- 08 - Serrated blade for Dynacutter

* The complete Dynacutter bowl includes a 5 litre / 6 qt - bowl, cover, reducer and a standard blade or serrated blade.

09 10 11 Master whip

Reference FM1	AC202
Length FM1	420 mm / 16,5"
Reference FM2	AC200
Length FM2	600 mm / 24"
Reference FM3	AC201
Length FM3	700 mm / 28"
Speed FM1-2-3	0 to 500 R.P.M.



SMX SERIES

NON-DETACHABLE /
DETACHABLE
600 / 850 W
75 TO 300 L



For all mixers:
Diameter 125 mm / 5"
Speed 11 000 R.P.M.



Ref. 0862
Wall support included

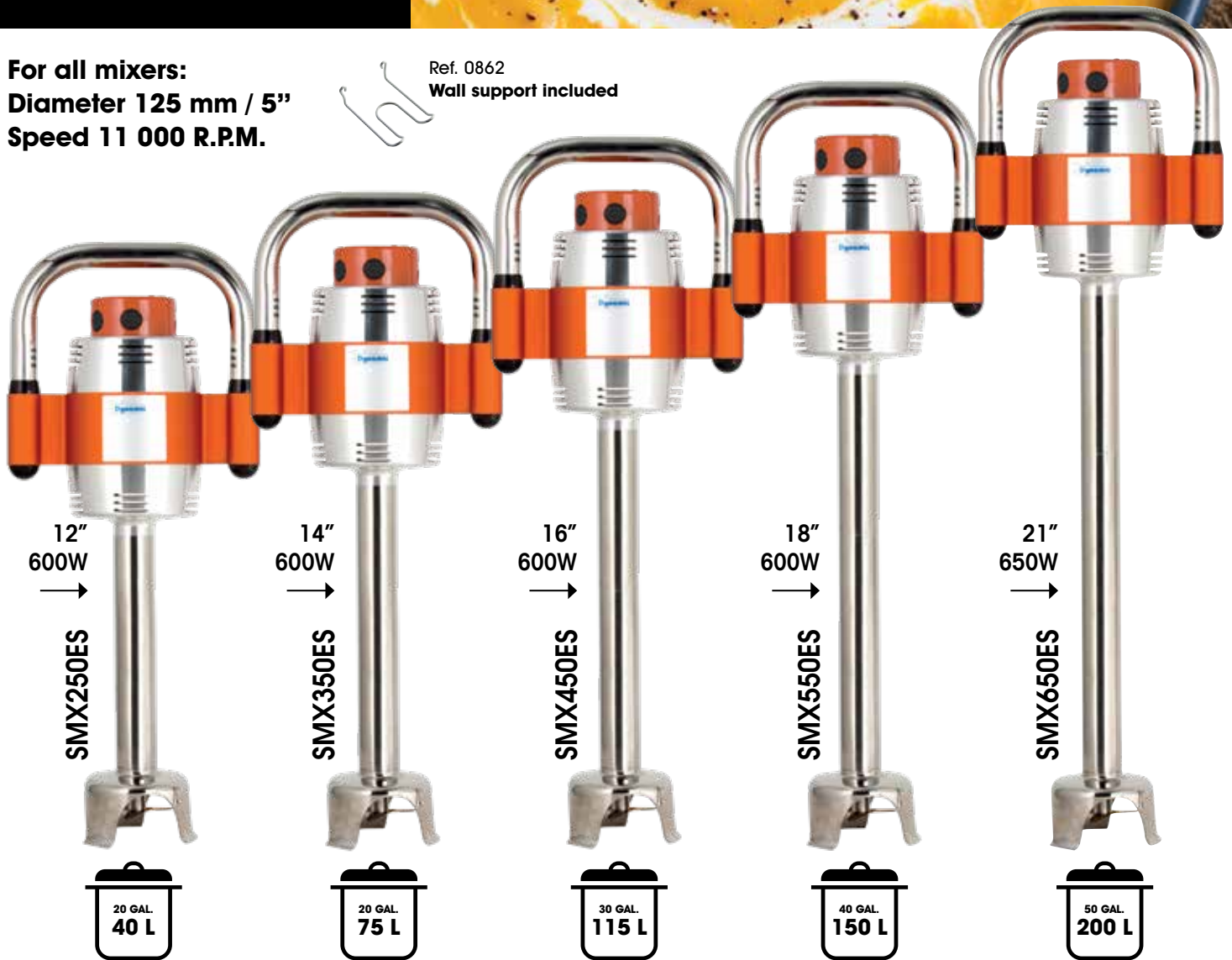

REFERENCE
MX041.1ES
TOTAL LENGTH
575 mm / 22"
ACTUAL WEIGHT
5,3 Kg / 11 lbs
SHIPPING WEIGHT
6,8 Kg / 15 lbs

REFERENCE
MX042.1ES
TOTAL LENGTH
626 mm / 24"
ACTUAL WEIGHT
5,5 Kg / 12 lbs
SHIPPING WEIGHT
7 Kg / 15,4 lbs

REFERENCE
MX043.1ES
TOTAL LENGTH
676 mm / 26"
ACTUAL WEIGHT
5,7 Kg / 12,6 lbs
SHIPPING WEIGHT
7,2 Kg / 16 lbs

REFERENCE
MX044.1ES
TOTAL LENGTH
728 mm / 28"
ACTUAL WEIGHT
5,9 Kg / 13 lbs
SHIPPING WEIGHT
7,4 Kg / 16,3 lbs

REFERENCE
MX002.1ES
TOTAL LENGTH
800 mm / 31,5"
ACTUAL WEIGHT
6,1 Kg / 13,4 lbs
SHIPPING WEIGHT
7,7 Kg / 17 lbs



SM020
Mixer weight support
clamp included with
SMX750ES / SMX850ES.

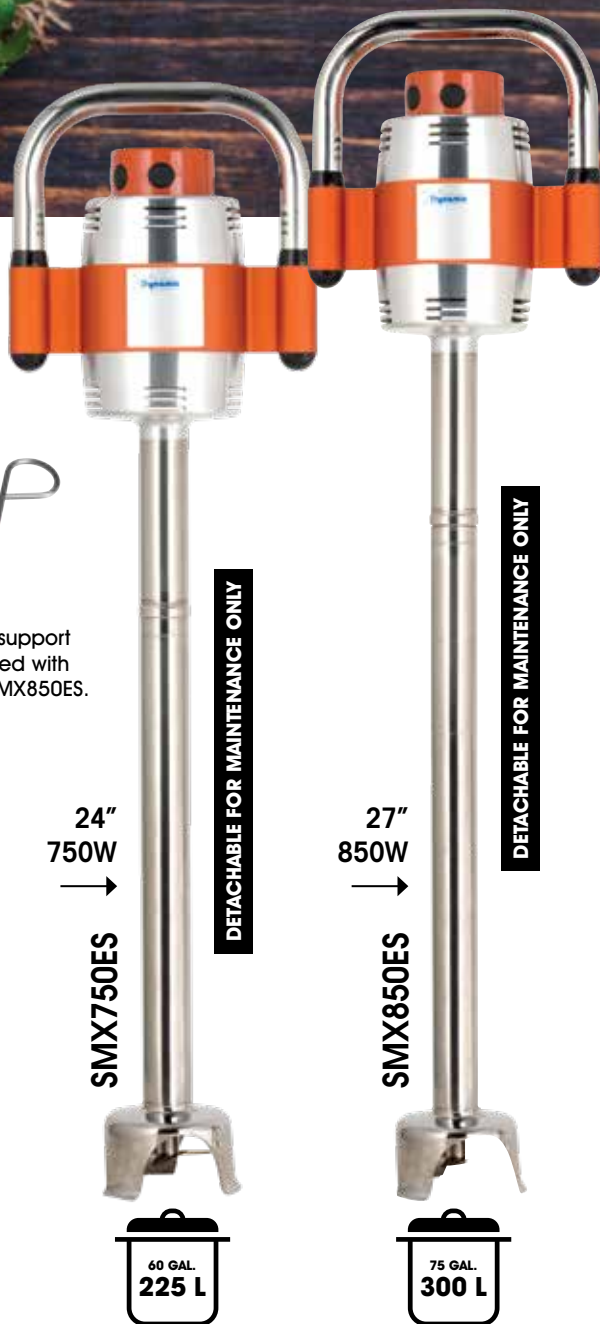

24"
750W

SMX750ES



REFERENCE
MX040.1ES
TOTAL LENGTH
870 mm / 34"
ACTUAL WEIGHT
6,5 Kg / 14,3 lbs
SHIPPING WEIGHT
8 Kg / 17,6 lbs

DETACHABLE FOR MAINTENANCE ONLY

27"
850W

SMX850ES



REFERENCE
MX001.1ES
TOTAL LENGTH
950 mm / 37,5"
ACTUAL WEIGHT
6,7 Kg / 14,7 lbs
SHIPPING WEIGHT
8,2 Kg / 18 lbs

DETACHABLE FOR MAINTENANCE ONLY



Top mounted support
brackets



Side mounted support
brackets

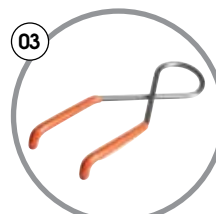

SM020



AC072T - 17"

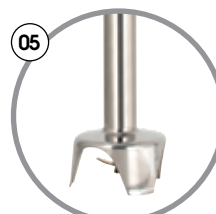

AC075T - 24"

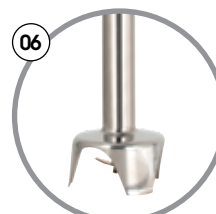

AC076T - 27"

01-Top mounted support brackets

	Dimension	Weight	CODE
SM4	400 mm / 16"	1,9 Kg / 4,2 lbs	SM001
SM6	600 mm / 24"	2,3 Kg / 5 lbs	SM002
SM8	800 mm / 32"	2,6 Kg / 5,7 lbs	SM003
SM10	1000 mm / 40"	2,8 Kg / 6,2 lbs	SM004
SM12	1200 mm / 48"	3,2 Kg / 7 lbs	SM005

02-Side mounted support brackets

	Weight	CODE
SA	0,7 Kg / 1,5 lbs	SM006

All brackets are easily dismantled and can be cleaned in the dishwasher. Adaptable only for Master and SMX series of mixers. Adjustable length. Practical and convenient, allows adjustable height and angle.

03-Mixer weight support clamp SM020

Mixer weight support clamp included with the Master detachable mixers, the SMX750ES and the SMX850ES.

04-SMX blender tool AC072T (only for SMX750ES and SMX850ES)

Total length	432 mm / 17"
Capacity	200 L

05-Mixer tool for SMX750ES AC075T

Total length	610 mm / 24"
Capacity	225 L

06-Mixer tool for SMX850ES AC076T

Total length	686 mm / 27"
Capacity	300 L



SUPPORT BRACKETS Used for weight assist and swivel, never leave mixer unattended.

POWER PRO

HEAVY DUTY
MOBILE MIXER

VARIABLE SPEED

2 200 W

400 L



REFERENCE

TB002

VOLTAGE

230V, 3 phase,
50/60Hz

SPEED

0 to 4000 R.P.M.



FRONT VIEW

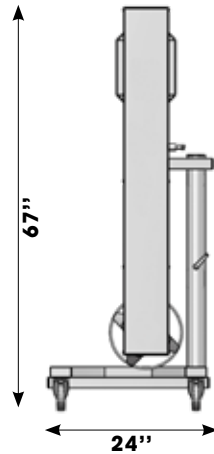

SIDE VIEW

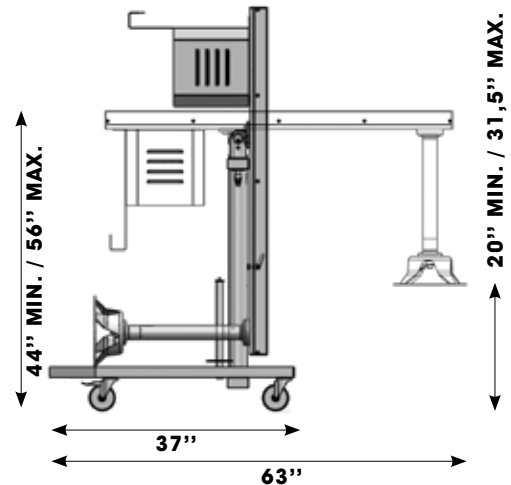

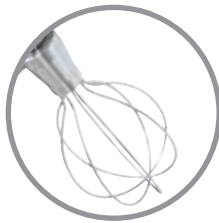

Whisk tool

Variable speed compulsory

Reference	TB003
Speed	400 to 600 R.P.M.
Diameter	170 mm / 6,5"
Height	470 mm / 18,5"

The whisk tool is ideal for delicate recipes and provides the ultimate in mixing flexibility.



Blender tool

Reference	TB004
Speed	2 800 to 4 000 R.P.M.
Diameter	100 mm / 3,8"
Height	90 mm / 3,5"

The blender tool is ideal for emulsifying soups and sauces.

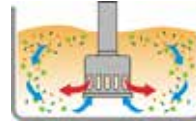

*See images below for texture difference.



Mixer tool

Reference	TB012
Speed	2 800 to 4 000 R.P.M.
Diameter	280 mm / 11"
Height	160 mm / 6,5"

The mixer tool is ideal for mixing large capacity preparations like soups and sauces in less than 5 minutes.



Potato masher tool

Variable speed compulsory

Reference	TB013
Speed	800 to 1 600 R.P.M.
Diameter	147 mm / 5,8"
Height	251 mm / 9,9"

The potato masher tool is designed for high volume purées that require 50 to 150 kg of potatoes.



Dispenser pump

Reference	TB030 (TB004 required)
Speed	-
Diameter	178 mm / 7"
Height	90 mm / 3,5"

The pump has a 2.5 m (8'2") long rubber tube which allows for an effortless and fast transfer of food preparations. Tube diameter 19mm (3/4"). Adaptable on the blender tool only (sold separately).



Portion control gun

Reference	TB040 (TB030 required)
Speed	-
Length	202 mm / 8"
Height	243 mm / 9,6"

The gun can be used as a complimentary tool for the transfer of food preparations in smaller containers. Adaptable on the pump attachment only (sold separately).



NEW

Foot Extension

Reference	TB015
Speed	-
Diameter	-
Height	300 mm / 12"

Allows for additional foot depth for added mixing flexibility.

*



01 - Texture obtained with mixer tool (TB012).



02 - Texture obtained with blender tool (TB004). The texture is creamy, smooth and perfect.

BLENDPRO

COMMERCIAL BLENDERS

WET AND DRY APPLICATION

1050 W
1.5 / 2 L

For all blenders:
3HP high speed motor
Two in one stainless steel cutting blade
Precision technology



Capacity
1.5L
→

BLENDPRO 1



REFERENCE
BLO01.1
L x W x H (INCHES)
15.9" x 8.4" x 9.3"
ACTUAL WEIGHT
8.8 LBS
SHIPPING WEIGHT
9.9 LBS

Capacity
1.5L
→

BLENDPRO 1T



REFERENCE
BLO01.1.T
L x W x H (INCHES)
15.9" x 8.4" x 9.3"
ACTUAL WEIGHT
8.8 LBS
SHIPPING WEIGHT
9.9 LBS

Capacity
1.5L
→

BLENDPRO 1TQ
SHIELDED BLENDER



REFERENCE
BLO01.1.TQ
L x W x H (INCHES)
15.9" x 8.4" x 9.3"
ACTUAL WEIGHT
13.5 LBS
SHIPPING WEIGHT
15.2 LBS



Variable speed control

3 one-touch auto-timer settings.

4 speed settings:
high, med, low & pulse.

3 one-touch auto-timer settings.

4 speed settings:
high, med, low & pulse.



BL756AT - Container only.
Capacity: 1.5L



BL756RT - Container only.
Capacity: 2L



BL756CT - Container only.
Capacity: 4L



REFERENCE
BLO02.1
L x W x H (INCHES)
13" x 9" x 11"
ACTUAL WEIGHT
9.5 LBS
SHIPPING WEIGHT
10.3 LBS



REFERENCE
BLO02.1.T
L x W x H (INCHES)
13" x 9" x 11"
ACTUAL WEIGHT
9.5 LBS
SHIPPING WEIGHT
10.3 LBS

Variable speed
control

3 one-touch auto-timer settings.

4 speed settings:
high, med, low & pulse.



BL1800 - Sound enclosure only.
For BlendPro 1 / BlendPro 1T.

SALAD SPINNERS

MANUAL
AND ELECTRIC
5 TO 20 L



Intertek

Certified for sanitation



E002
SD92 Manual salad spinner



E004
SD92SC Manual salad spinner SEALED COVER



E007
SD MINI Manual salad spinner sealed cover



TOTAL HEIGHT
342 mm / 13,5"
DIAMETER
275 mm / 10,8"
ACTUAL WEIGHT
1,6 Kg / 3,5 lbs
SHIPPING WEIGHT
1,6 Kg / 3,5 lbs

Maximum
2 heads of lettuce



E001
SD99 Manual salad spinner



TOTAL HEIGHT
460 mm / 18"
DIAMETER
330 mm / 13"
ACTUAL WEIGHT
2,4 Kg / 5,3 lbs
SHIPPING WEIGHT
3,1 Kg / 6,8 lbs

Maximum
4 heads of lettuce



E002.B
SD92 Manual salad spinner with stabilizing base



TOTAL HEIGHT
530 mm / 21"
DIAMETER
430 mm / 17"
ACTUAL WEIGHT
3,6 Kg / 7,9 lbs
SHIPPING WEIGHT
4,8 Kg / 10,5 lbs

Maximum
8 heads of lettuce



E004.B
SD92SC Manual salad spinner SEALED COVER with stabilizing base



TOTAL HEIGHT
530 mm / 21"
DIAMETER
430 mm / 17"
ACTUAL WEIGHT
3,6 Kg / 7,9 lbs
SHIPPING WEIGHT
4,8 Kg / 10,5 lbs

Maximum
8 heads of lettuce



WITH 1 MINUTE TIMER AND TOUCH SWITCH

E003.1.B.T



EM98 Electric salad spinner with stabilizing base SSB1

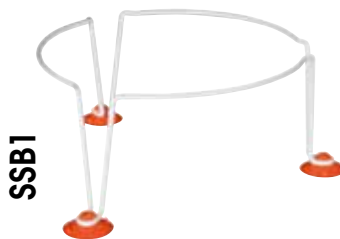

SSB1

SSB1 Stabilizing base*



TOTAL HEIGHT

630 mm / 25"

DIAMETER

430 mm / 17"

ACTUAL WEIGHT

8,3 Kg / 18,3 lbs

SHIPPING WEIGHT

10 Kg / 22 lbs

OUTPUT

200 W

SPEED

500 R.P.M.

TOTAL HEIGHT

170 mm / 6,7"

DIAMETER

360 mm / 14,2"

*** FOR SD92, SD92SC AND EM98**

CITRUS JUICER



PERFECT FOR ALL YOUR JUICING NEEDS



PA96 Citrus juicer

2 juicing cones included.

Reference	PA001.1
Total length	330 mm / 13"
Diameter	220 mm / 8,6"
Actual weight	6,3 Kg / 13,9 lbs
Voltage	115 V or 230 V
Output	200 W
Speed	1 500 R.P.M.

RICER/FOOD MILL

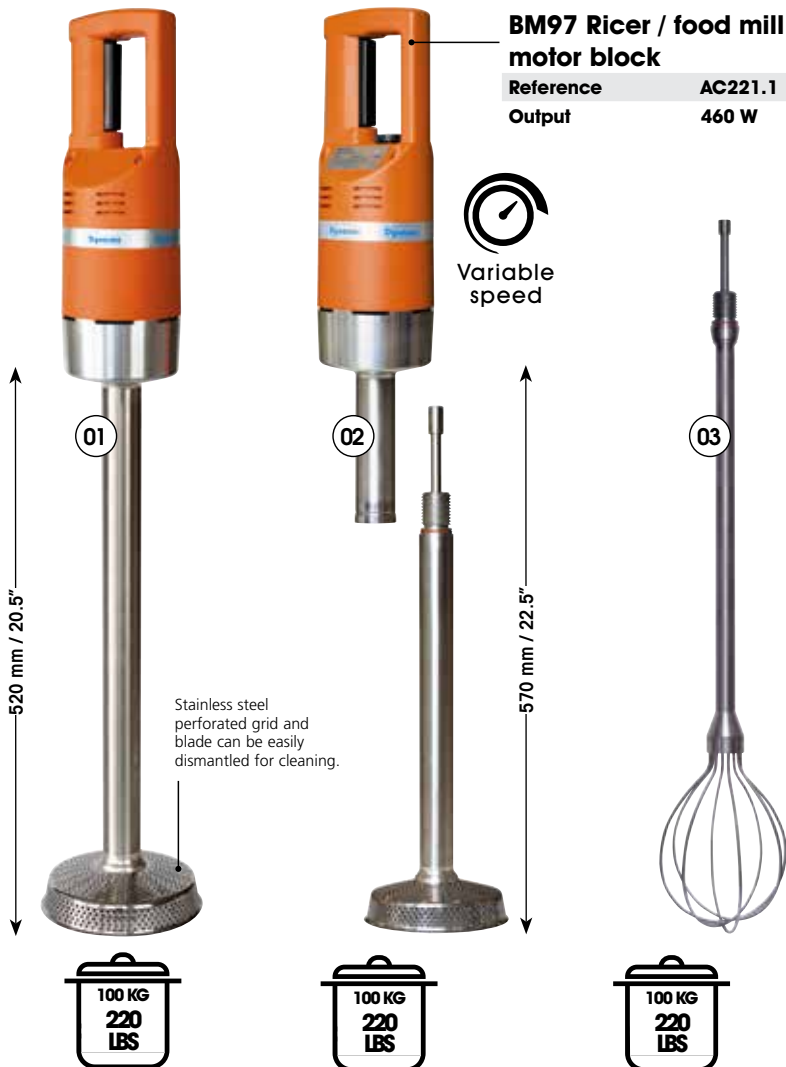

01 - PP97 Ricer / food mill non-detachable

Reference	PP001.1
Total length	870 mm / 34"
Mixer tool length	520 mm / 20,5"
Diameter	170 mm / 6,8"
Actual weight	4,9 Kg / 10,7 lbs
Shipping weight	5,9 Kg / 13 lbs
Output	460 W
Speed	0 to 500 R.P.M.

02 - PP97 Plus Ricer / food mill detachable

Reference	PP002.1
Total length	920 mm / 36"
Mixer tool length	570 mm / 22,5"
Diameter	170 mm / 6,8"
Actual weight	4,9 Kg / 10,7 lbs
Shipping weight	5,9 Kg / 13 lbs
Output	460 W
Speed	0 to 500 R.P.M.

03 - FM97 Whisk tool for PP97 Plus

Reference	AC208
Total length	690 mm / 27"
Actual weight	1,5 Kg / 3,3 lbs

Comes with handle.





Demo Video

MANUAL DICER

DYNACUBE

Grid set with pusher

Cutting grid sizes are estimates only.



NEW AC065 - 5 x 5mm / 3/32" x 3/32"

NEW CL007 = Dynacube complete



AC060 - 7 x 7mm / 1/8" x 1/8"

CL005 = Dynacube complete



AC061 - 8,5 x 8,5mm / 1/4" x 1/4"

CL003 = Dynacube complete



AC062 - 10 x 10mm / 3/8" x 3/8"

CL006 = Dynacube complete



AC063 - 14 x 14mm / 1/2" x 1/2"

CL008 = Dynacube complete



AC064 - 17 x 17mm / 3/4" x 3/4"

CL009 = Dynacube complete



NO DIRECT CONTACT WITH BLADES



6 DIFFERENT GRID SIZES AVAILABLE



VERSATILE



100% PRODUCT YIELD AND CONSISTENT CUTS



TOTAL HEIGHT

330 mm / 13"

DIAMETER

400 mm / 15,8"

ACTUAL WEIGHT

3,1 Kg / 6,8 lbs

SHIPPING WEIGHT

4,4 Kg / 9,7 lbs



MORTAGNE - SUR - SÈVRE
FRANCE



CUSTOMER SERVICE

1-800-267-7794

514-956-0127



EMAIL US

GENERAL

info@dynamicmixers.com

ORDERS

orders@dynamicmixers.com



WEB

dynamicmixersusa.com

dynamicmixers.ca

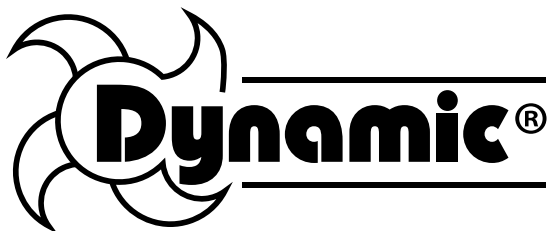

1320 ROUTE 9 #1352
CHAMPLAIN, NY - 12919



3227 BOUL. PITFIELD
MONTREAL, QC - H4S 1H3

TERMS AND CONDITIONS

PRICING. All prices are subject to change without notice. Prices do not include freight, handling or delivery charges, air shipment charges or taxes (sales, excise, duties, etc.). The Purchaser shall be responsible for collecting and/or paying any and all such taxes. Such charges may, at Dynamic's sole and exclusive discretion, be prepaid by Dynamic and reimbursed by the Purchaser.

APPLICABLE POLICIES FOR RESALE OF PRODUCTS. All product selling prices are determined at the discretion of authorized distributors with the exception of specific products determined by Dynamic to have Minimum Advertised Pricing («MAP»). Failure to comply with our MAP Policy may affect your status as an authorized distributor. Dynamic reserves the right to take the necessary steps in maintaining our integrity with regards to our pricing.

ORDERS. No minimum orders required. Each order must reference Dynamic's quote (if any), the requested Products, and any other information requested by Dynamic. All orders and transactions are subject to acceptance or cancellation by Dynamic, in Dynamic's sole discretion. Each accepted order will be interpreted as a single agreement, independent of any other orders. All orders must be sent by email at orders@dynamicmixers.com or by fax at 1(877)668-6623.

SHIPPING AND DELIVERY. Prepaid Freight qualifies at \$3000 net (excluding PowerPro) on individual orders shipped to one location. Prepaid Freight Address exclusions are Hawaii, Alaska, Puerto Rico and Canada far North. Additional exclusions may apply. Orders not meeting Prepaid freight criteria are F.O.B. Memphis, TN USA or F.O.B. Montreal, QC. Canada. A fee may apply on 'Drop Ship' orders. Shipping specifics and delivery dates advised are estimates only and Dynamic is not responsible on variances. Dynamic reserves the right to refuse or cancel any order. On occasion, products contained in a single order may ship separately. Dynamic reserves the right to choose the carrier on specific orders. Freight charges are based on product weight & destination zip code or postal code. Product damage or loss incurred during shipment is the sole responsibility of the product purchaser. The purchaser must notify Dynamic regarding any product inconsistencies within 7 days of receipt of order including damages and shortages.

RETURNS. Returns cannot be accepted without a Return Authorization number issued by Dynamic and a return request must be submitted within seven (7) days of invoice date. Product returns must be in original packaging and unopened. Damaged and/or used Products will not be accepted. A 25% restocking charge will apply on all returns. Products deemed «Special Order» cannot be returned.

INVOICING AND PAYMENT. Dynamic may invoice parts of an order separately, or may invoice purchases of Products in one invoice. Invoices are due and payable within the time period noted on the Purchaser's invoice. All Products sold remain the exclusive property of Dynamic until invoice is paid in full.

WARRANTY. Dynamic will guarantee all new Products to be free from defects in materials and workmanship. Electric Products include a one (1) year parts and labor carry in bench warranty with the exception of component replacements necessary through regular "wear and tear". Manual Products include a one (1) year limited parts warranty. Warranty is valid, providing the Products have been used in accordance with Dynamic's operating recommendations and guidelines. Dynamic or any authorized service center will repair or replace, at Dynamic's discretion and after examination, any or all manufacturer's defective parts during the warranty period. Any damage caused by improper use, abuse, dropping, or similar accidental damage resulting in breakage will render the warranty null and void. During the warranty period, only Dynamic or one of its authorized service centers may perform evaluations or repairs to Products. Warranty will be void on any equipment which has been dismantled or tampered with during the warranty period if this has been done by unauthorized centers or personnel.

DISCLAIMER. Specifics contained herein with regards to Product text and/or Product images may change without notice.



A GROUP NADIA COMPANY