

**Installation Instructions**  
**Model: AB08 3155**  
**Single Lever Kitchen Faucet with Side Spray**



**TABLE OF CONTENTS**

Preparation	2
Materials & Tools	2
Parts	2
Installation	3-4
Care and Cleaning	5
Warranty	5
Return Policy	5
Asking for Assistance	5

Please read all instructions carefully before starting the installation.

**PREPARATION**

● **Before You Begin**

Before installing any Dawn product in your new or remodeled kitchen, you should make sure that you are in compliance with all local plumbing codes.

● **Check The Accessory Items**

Before installation, please check the condition of the product and, if appropriate, its components. If there is any problem with the product and/or its components, please contact the store you purchased it from for a replacement. As soon as you have inspected your product, please return it to its original packaging until you are ready to install it.

● **Handle With Care**

To protect its finish and avoid damage before and after installation, please handle the product with care. For care and cleaning tips after installation, please refer to the *Care and Cleaning Guide* in this instruction guide.

**MATERIALS & TOOLS**

Assorted Screwdrivers, Adjustable Wrenches, Pencil, Masking Tape, Thread Sealant, Other Tools as Needed

**PARTS**

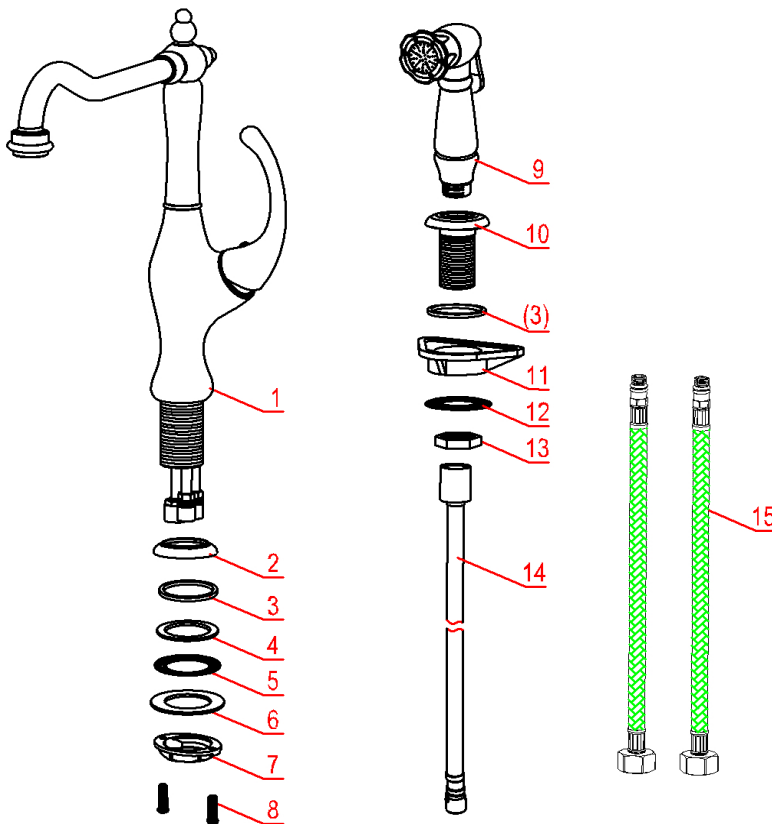

Item	Qty.
1: Main Body	1
2: Base	1
3: Washer1	2
4: Washer2	1
5: Clamping Ring	1
6: Gasket	1
7: Nut	1
8: Screw	2
9: Side Spray	1
10: Shower Hook	1
11: Compress Cover	1
12: Clamping Ring 2	1
13: Hexagon Nut	1
14: Shower Hose	1
15: Spray Hose	2

\*Drawings are for reference only. Please refer to actual product for exact size, shape and parts.

\*Dawn reserves the right to make revisions in the design of faucets without notice for improvement of product performance and quality.

INSTALLATION

**IMPORTANT:** Recommended for professional installers only. The installer maintains responsibility for installing the product safely.

- The faucet main body is already assembled. Do not disassemble it.
- Thoroughly clean the inside of all pipes with a cloth before installation.
- Check all connections for leaks after installation.
- Water pressure range 0.05 Mpa to 1 Mpa; water temperature range 39°F to 194°F (4°C to 90°C).

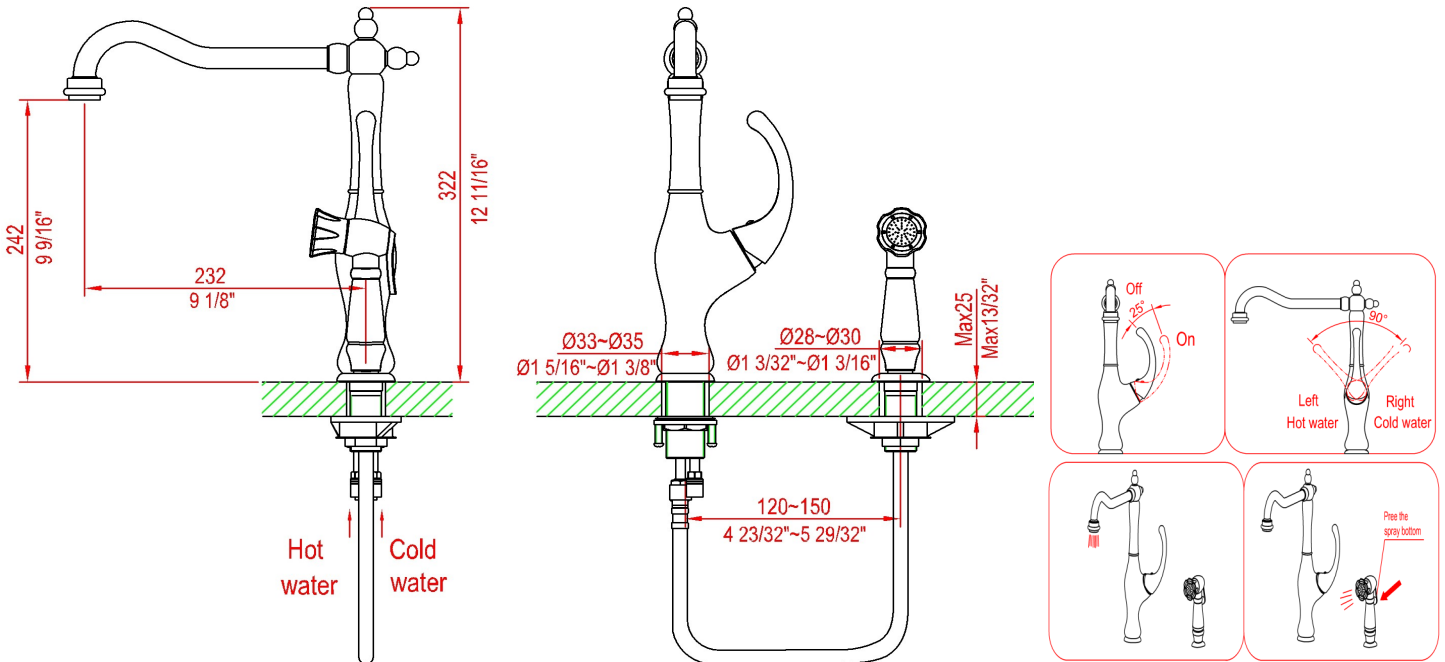
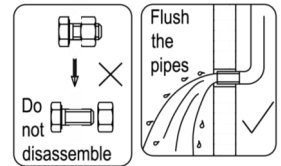

<p><b>1.</b></p>	<p><b>2.</b></p>
<p>1. Before installation, be sure of the indicated thickness and hole of installation board. Make two holes as per above dimension.</p>	<p>2. Remove the nut(7) from main body(1). Remove gasket(6), clamping ring(5) and washer(2). Leaving washer 1(3) and base(2) on the main body. Install supply hoses(15) to main body(1). Then insert the faucet through the faucet hole. Reinstall the washer 2(4), clamping ring(5), gasket(6) and nut(7) from bottom.</p>

**INSTALLATION**

*IMPORTANT: Recommended for professional installers only. The installer maintains responsibility for installing the product safely.*

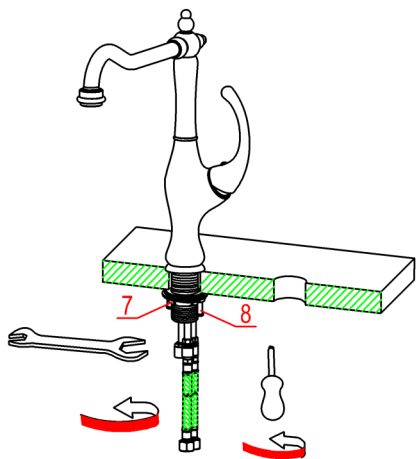
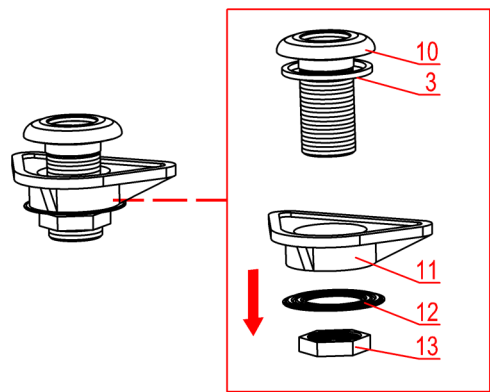
<p><b>3.</b></p> 	<p><b>4.</b></p> 
<p>3. After adjusting the direction of the main body, tighten the nut (7) with a wrench and screw up the screw (8) with a phillips screwdriver.</p>	<p>4. Remove the hexagon nut (13), clamping ring (12) and compress cover (11) from shower hook (10). Leaving washer (3) on shower hook (10).</p>

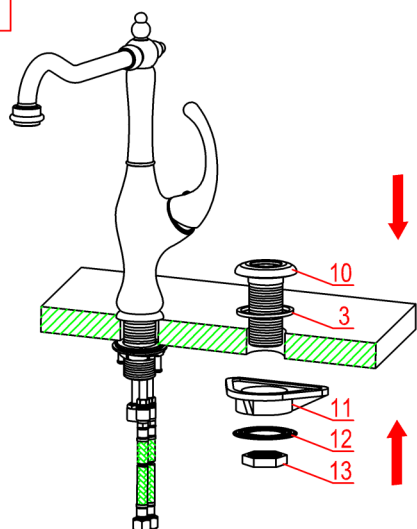
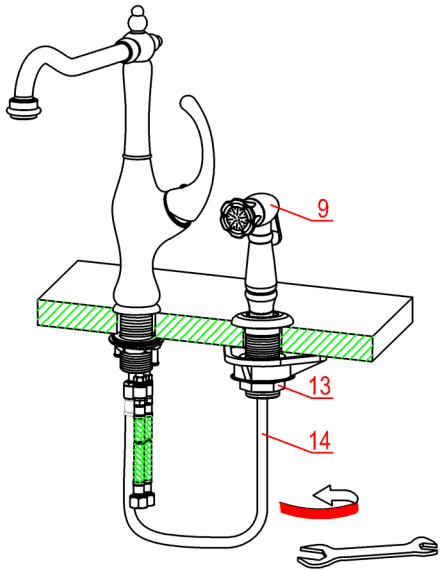
<p><b>5.</b></p> 	<p><b>6.</b></p> 
<p>5. Insert the shower hook (10) through the installation hole as shown in above figure. Reinstall compress cover (11), clamping ring (12) and hexagon nut (13) from bottom.</p>	<p>6. After adjusting the direction of the shower hook, tighten the hexagon nut (13) with a wrench. Connect side spray (9) and main body with shower hose (14). Install the water supply hoses correctly. Then check for leaks.</p>

**LEGAL DISCLAIMER:**

- This instruction guide is done as a public service to customers of Dawn Kitchen & Bath Products, Inc. ("Dawn"). For special situations or further assistance, please consult professionals.
- All products should be inspected by customers upon receipt and before any installation. Any defective product should be reported immediately and should NOT be installed.
- Requirements may vary for installation in a granite, marble, stone, or butcher block countertop.
- Installation by professional installers is highly recommended. Dawn assumes no liability for any damages incurred through the use of information provided in this guide.

---

## CARE AND CLEANING

---

To maintain the product and to avoid possible damage:

- Clean as and when required. Regular cleaning prevents scale buildup and water spotting.
- To clean, flush with clean water and dry with a soft cloth.
- To remove scale or water spots, only use cleaners made specifically for that purpose. Apply cleaners to cleaning cloths, pads, or sponges first; do not apply directly onto the product.
- Do not allow any cleaning product to remain on your faucet for longer than necessary.
- Do not use any abrasive cleaning products, such as scrubbing detergent, polisher, sand-cloth, paper tissue, or scrapper.
- Do not use detergents or soaps that contain acid or that are undissolvable.
- Take the aerator off and clean it when necessary.
- After cleaning, rinse thoroughly with clean water to remove any cleaner residue.



---

## WARRANTY

---

All Dawn products have been manufactured and tested to the highest quality standards by Dawn Kitchen & Bath Products, Inc. ("Dawn"). This warranty is limited to Dawn products purchased and installed in the United States. Dawn Kitchen & Bath Products, Inc. warrants its products to be free from manufacturing defects in material and workmanship during normal residential use for as long as the original consumer purchaser owns his or her home. This warranty only extends to the original consumer purchaser and this warranty is non-transferable. If any defect is found in normal residential use, Dawn Kitchen & Bath Products, Inc. will, at its election, repair, provide a replacement part of product, or make appropriate adjustment at no charge (excluding labor charges and other incidental or consequential costs). Damage to a product caused by accident, misuse, or abuse is NOT covered by this warranty. Improper care and cleaning will void the warranty. If Dawn is unable to provide a replacement and repair cannot be made, Dawn may elect to refund the purchase price to the original consumer purchaser in exchange for the return of the product. (IMPORTANT: The original consumer purchaser should be responsible for inspecting products upon receipt. Any defective product should be reported immediately and should NOT be installed.)

*THIS WARRANTY DOES NOT COVER, AND DAWN DISCALIMS ANY LIABILITY FOR:*

- Conditions or damage NOT resulting from defects in material or workmanship.
- Conditions or damage resulting from
  - ① normal wear and tear, improper installation, improper maintenance, misuse, abuse, negligence, accident or alteration, or
  - ② the use of abrasive cleaning products or the use of the product in any manner contrary to the product instructions, or
  - ③ conditions in the home such as excessive water pressure or corrosion.
- Labor, shipping, or other costs for the disconnection, reinstallation, or return of the product for warranty service, or costs for installation or reinstallation of the product.
- Parts, accessories, connected materials, or related products not manufactured by Dawn.

Dawn reserves the right to inspect any Dawn product reported to be defective prior to any repair or replacement. Repair and replacement costs EXCLUDE shipping, labor, and consequential expenses. To request warranty service, please contact Dawn Customer Service at toll-free 1-877-Dawn-USA. *NOTE:* Proof of purchase (original sales receipt) and description of problem must be provided with all warranty claims.

---

## RETURN POLICY

---

You may only return new, uninstalled, or unused items sold and fulfilled by Dawn Kitchen & Bath Products, Inc. for a full refund within 30 days of delivery. Items must be returned in its original package. Returns of used items or returns after 30 days of delivery may be accepted with a 15% restocking fee. Dawn will pay for return shipping costs only if the return is a result of our fault. If you receive a faulty product and need to exchange it for the same product, please contact our customer service via phone, fax, or e-mail to request a replacement. If you would like to exchange a product for a different one, please first return the original product to our location at [27688 Industrial Blvd., Hayward, CA 94545](http://27688IndustrialBlvd.com) and then place a new order.

*PARTIAL REFUNDS MAY BE GIVEN TO:*

- Most of the items that are returned after 30 days of delivery
- Any item not returned in the condition it was delivered
- Any item that has obvious signs of use
- A 15% restocking fee will apply to all used items or items returned after 30 days of delivery.

---

## ASKING FOR ASSISTANCE

---

Dawn Customer Service Department  
27688 Industrial Blvd., Hayward, CA 94545  
Toll-Free: 877-DAWN-USA (877-329-6872)  
E-mail: [dp@dawnusa.net](mailto:dp@dawnusa.net) Web: [www.dawnusa.net](http://www.dawnusa.net)