

BUNN®

JDF-2S JDF-4S Silver Series®



INSTALLATION & OPERATING GUIDE

BUNN-O-MATIC CORPORATION

POST OFFICE BOX 3227

SPRINGFIELD, ILLINOIS 62708-3227

PHONE: (217) 529-6601 FAX: (217) 529-6644

To ensure you have the latest revision of the Operating Manual, or to view the Illustrated Parts Catalog, Programming Manual, or Service Manual, please visit the Bunn-O-Matic website, at www.bunn.com. This is absolutely FREE, and the quickest way to obtain the latest catalog and manual updates. For Technical Service, contact Bunn-O-Matic Corporation at 1-800-286-6070.



BUNN-O-MATIC COMMERCIAL PRODUCT WARRANTY

Bunn-O-Matic Corp. ("BUNN") warrants equipment manufactured by it as follows:

- 1) Airpots, thermal carafes, decanters, GPR servers, iced tea/coffee dispensers, MCP/MCA pod brewers thermal servers and Thermofresh servers (mechanical and digital)- 1 year parts and 1 year labor.
- 2) All other equipment - 2 years parts and 1 year labor plus added warranties as specified below:
 - a) Electronic circuit and/or control boards - parts and labor for 3 years.
 - b) Compressors on refrigeration equipment - 5 years parts and 1 year labor.
 - c) Grinding burrs on coffee grinding equipment to grind coffee to meet original factory screen sieve analysis - parts and labor for 4 years or 40,000 pounds of coffee, whichever comes first.

These warranty periods run from the date of installation BUNN warrants that the equipment manufactured by it will be commercially free of defects in material and workmanship existing at the time of manufacture and appearing within the applicable warranty period. This warranty does not apply to any equipment, component or part that was not manufactured by BUNN or that, in BUNN's judgment, has been affected by misuse, neglect, alteration, improper installation or operation, improper maintenance or repair, non periodic cleaning and descaling, equipment failures related to poor water quality, damage or casualty. In addition, the warranty does not apply to replacement of items subject to normal use including but not limited to user replaceable parts such as seals and gaskets. This warranty is conditioned on the Buyer 1) giving BUNN prompt notice of any claim to be made under this warranty by telephone at (217) 529-6601 or by writing to Post Office Box 3227, Springfield, Illinois 62708-3227; 2) if requested by BUNN, shipping the defective equipment prepaid to an authorized BUNN service location; and 3) receiving prior authorization from BUNN that the defective equipment is under warranty.

THE FOREGOING WARRANTY IS EXCLUSIVE AND IS IN LIEU OF ANY OTHER WARRANTY, WRITTEN OR ORAL, EXPRESS OR IMPLIED, INCLUDING, BUT NOT LIMITED TO, ANY IMPLIED WARRANTY OF EITHER MERCHANTABILITY OR FITNESS FOR A PARTICULAR PURPOSE. The agents, dealers or employees of BUNN are not authorized to make modifications to this warranty or to make additional warranties that are binding on BUNN. Accordingly, statements by such individuals, whether oral or written, do not constitute warranties and should not be relied upon.

If BUNN determines in its sole discretion that the equipment does not conform to the warranty, BUNN, at its exclusive option while the equipment is under warranty, shall either 1) provide at no charge replacement parts and/or labor (during the applicable parts and labor warranty periods specified above) to repair the defective components, provided that this repair is done by a BUNN Authorized Service Representative; or 2) shall replace the equipment or refund the purchase price for the equipment.

THE BUYER'S REMEDY AGAINST BUNN FOR THE BREACH OF ANY OBLIGATION ARISING OUT OF THE SALE OF THIS EQUIPMENT, WHETHER DERIVED FROM WARRANTY OR OTHERWISE, SHALL BE LIMITED, AT BUNN'S SOLE OPTION AS SPECIFIED HEREIN, TO REPAIR, REPLACEMENT OR REFUND.

In no event shall BUNN be liable for any other damage or loss, including, but not limited to, lost profits, lost sales, loss of use of equipment, claims of Buyer's customers, cost of capital, cost of down time, cost of substitute equipment, facilities or services, or any other special, incidental or consequential damages.

392, AutoPOD, AXIOM, BrewLOGIC, BrewMETER, Brew Better Not Bitter, BrewWISE, BrewWIZARD, BUNN Espresso, BUNN Family Gourmet, BUNN Gourmet, BUNN Pour-O-Matic, BUNN, BUNN with the stylized red line, BUNNlink, Bunn-O-Matic, Bunn-O-Matic, BUNNserve, BUNNSERVE with the stylized wrench design, Cool Froth, DBC, Dr. Brew stylized Dr. design, Dual, Easy Pour, EasyClear, EasyGard, FlavorGard, Gourmet Ice, Gourmet Juice, High Intensity, iMIX, Infusion Series, Intellisteam, My Café, Phase Brew, PowerLogic, Quality Beverage Equipment Worldwide, Respect Earth, Respect Earth with the stylized leaf and coffee cherry design, Safety-Fresh, savemycoffee.com, Scale-Pro, Silver Series, Single, Smart Funnel, Smart Hopper, SmartWAVE, Soft Heat, SplashGard, The Mark of Quality in Beverage Equipment Worldwide, ThermoFresh, Titan, trifacta, Velocity Brew, A Partner You Can Count On, Air Brew, Air Infusion, Beverage Bar Creator, Beverage Profit Calculator, Brew better, not bitter., BUNNSource, Coffee At Its Best, Cyclonic Heating System, Daypart, Digital Brewer Control, Nothing Brews Like a BUNN, Pouring Profits, Signature Series, Tea At Its Best, The Horizontal Red Line, Ultra are either trademarks or registered trademarks of Bunn-O-Matic Corporation.

CONTENTS

Warranty	2
User Notices	3
Initial Set-Up & Electrical Requirements	4
Plumbing Requirements	4
CE Requirements	4
Door Cover Installation	5
Plumbing Hookup	6
Initial Fill	6
Loading	15
Priming	15
Operating Controls	8
Dispenser Use	10
Portion Control Option	10
Cleaning	12
Adjustments & Optional Settings	14
Function Lists	18
Troubleshooting	20
Coolant Diagram	26
Schematic Wiring Diagram	27
Quick Setup Guide	29

USER NOTICES

Carefully read and follow all notices on the equipment and in this manual. They were written for your protection. All notices are to be kept in good condition. Replace any unreadable or damaged labels.

As directed in the International Plumbing Code of the International Code Council and the Food Code Manual of the Food and Drug Administration (FDA), this equipment must be installed with adequate backflow prevention to comply with federal, state and local codes. For models installed outside the U.S.A., you must comply with the applicable Plumbing /Sanitation Code for your area.

00656.0001

⚠ WARNING

⚡

**HAZARDOUS
VOLTAGE**

**DISCONNECT FROM
POWER SOURCE
BEFORE REMOVING!**

⚡

12559.0003

⚠ WARNING	⚠ AVERTISSEMENT
<ul style="list-style-type: none"> • DO NOT OVERLOAD CIRCUIT. • ALWAYS ELECTRICALLY GROUND THE CHASSIS. • DO NOT DEFORM PLUG OR CORD. • FOLLOW NATIONAL AND LOCAL ELECTRICAL CODES. • KEEP COMBUSTIBLES AWAY. 	<ul style="list-style-type: none"> • NE PAS SURCHARGER LE CIRCUIT. • TOUJOURS METTRE LE BOITIER À LA MASSE. • NE PAS DÉFORMER LA FICHE OU LE CORDON. • SE CONFORMER AUX CODES NATIONAL OU LOCAL D'ÉLECTRICITÉ. • GARDER LES PRODUITS COMBUSTIBLES À DISTANCE.
<p>FAILURE TO COMPLY RISKS EQUIPMENT DAMAGE, FIRE OR SHOCK HAZARD.</p>	<p>TOUT MANQUEMENT À SE CONFORMER À CES DIRECTIVES PEUT ENTRAÎNER DES DOMMAGES À L'ÉQUIPEMENT OU PRODUIRE DES DANGERS D'INCENDIE OU D'ÉLECTROCUTION.</p>
<p>READ THE ENTIRE OPERATING MANUAL INCLUDING THE LIMIT OF WARRANTY AND LIABILITY BEFORE BUYING OR USING THIS PRODUCT.</p>	<p>VEUILLEZ LIRE LE MANUEL DE FONCTIONNEMENT EN ENTIER, Y COMPRIS LES LIMITES DE GARANTIES ET RESPONSABILITÉS, AVANT D'ACHETER OU D'UTILISER LE PRÉSENT PRODUIT.</p>
<p>THIS EQUIPMENT IS ENERGIZED AT ALL TIMES UNLESS ELECTRICALLY DISCONNECTED.</p>	<p>L'ÉQUIPEMENT EST TOUJOURS SOUS TENSION LORSQU'IL N'EST PAS DÉBRANCHÉ.</p>

00986.7000A 10/07 ©2007 Bunn-O-Matic Corporation

00986.7000

⚠ WARNING

<p>Moving Parts.</p> <p>Do not operate unit with this panel removed.</p>	<p>Risk Of Electrical Shock.</p> <p>Disconnect power before servicing unit.</p>
---	--

⚠ AVERTISSEMENT

<p>Pièces amovibles</p> <p>Ne pas utiliser l'appareil lorsque le panneau est enlevé.</p>	<p>Risk de choc électrique.</p> <p>Débrancher le cordon d'alimentation de l'appareil avant de faire l'entretien.</p>
---	---

27442.7000

CHARGE

Type R134A, Amount **10** oz (283 gm)

Design Pressures:

High **335** psi (23 bar) (2.31 MPa)

Low **88** psi (6 bar) (0.61 MPa)

33461.0000
JDF-4S

CHARGE

Type R134A, Amount **9** oz (255 gm)

Design Pressures: High **255** psi (15.5 bar)

Low **36** psi (2.5 bar)

33461.0001
JDF-2S

INITIAL SET-UP

CAUTION: The dispenser is very heavy! Use care when lifting or moving it. Use at least two people to lift or move the dispenser. Place dispenser on a sturdy counter or shelf able to support at least 150 lbs. (68 kg). This dispenser is designed for indoor use only.

Set the dispenser on the counter where it will be used. This dispenser requires a minimum of 4 inches (102 mm) of air clearance at the rear and 8 inches (203 mm) of air clearance above the dispenser. Minimal clearance is required between the dispenser sides and the wall or another appliance. For optimum performance, **do not** let warm air from surrounding machines blow on the dispenser. Leave some space so the dispenser can be moved for cleaning.

CE REQUIREMENTS

- This appliance must be installed in locations where it can be overseen by trained personnel.
- For proper operation, this appliance must be installed where the temperature is between 5°C to 35°C.
- Appliance shall not be tilted more than 10° for safe operation.
- An electrician must provide electrical service as specified in conformance with all local and national codes.
- This appliance must not be cleaned by water jet.
- This appliance is not intended for use by persons (including children) with reduced physical, sensory or mental capabilities, or lack of experience and knowledge, unless they have been given instructions concerning use of this appliance by a person responsible for its safety.
- Children should be supervised to ensure they do not play with the appliance.
- If the power cord is ever damaged, it must be replaced by the manufacturer or authorized service personnel with a special cord available from the manufacturer or its authorized service personnel in order to avoid a hazard.
- Machine must not be immersed for cleaning.

ELECTRICAL REQUIREMENTS

CAUTION: The dispenser must be disconnected from the power source until specified in *Electrical Hook-Up*.

The 120V rated dispensers have an attached cord set and require a 2-wire, grounded, individual branch circuit rated 120 volts ac, 15 amp, single phase, 60Hz. The mating connector must be a NEMA 5-15R.

The 230V rated dispenser has an attached cord set and requires an attachment plug cap rated at least 230 volts ac, 15 amp. The attachment plug cap must meet with applicable national/local electrical codes.

Refer to the data plate for exact electrical requirements.

ELECTRICAL HOOK-UP

CAUTION: Improper electrical installation will damage electronic components.

1. An electrician must provide electrical service as specified.
2. Using a voltmeter, check the voltage and color coding of each conductor at the electrical source.
3. Confirm that the refrigeration switch near the main control board is in the **OFF** position.
4. Connect the dispenser to the power source.
5. If plumbing is to be hooked up later, be sure the dispenser is disconnected from the power source. If plumbing has been hooked up, the dispenser is ready for *Initial Fill*.

PLUMBING REQUIREMENTS

This dispenser must be connected to a **COLD WATER** system with operating pressure between 20 and 100 psi (138 and 690 kPa). This water source must be capable of producing a minimum flow rate of 3 fluid ounces (88.7 milliliters) per second. A shut off valve should be installed in the line before the dispenser. Install a regulator in the line when pressure is greater than 100 psi (690 kPa) to reduce it to 50 psi (345 kPa). The regulator is also necessary if the water source has pressure fluctuations. The main water inlet is a 3/8" (9.52 mm) MFL connection.

NOTE- At least 18 inches (457 mm) of an FDA approved flexible beverage tubing, such as reinforced braided polyethylene, before the dispenser will facilitate movement to clean the countertop. It can be purchased direct from BUNN-O-MATIC (part number 34325.10__ [see Illustrated Parts Catalog for complete part number.]) BUNN-O-MATIC does not recommend the use of saddle valves to install the dispenser. The size and shape of the hole(s) made in the supply line(s) by saddle valves may restrict water flow.

As directed in the International Plumbing Code of the International Code Council and the Food Code Manual of the Food and Drug Administration (FDA), this equipment must be installed with adequate backflow prevention to comply with federal, state and local codes. For models installed outside the U.S.A., you must comply with the applicable Plumbing /Sanitation Code for your area.

DOOR COVER INSTALLATION

1. Install door cover by first plugging the door harness connector into the machine harness connector located at the bottom of the machine door.

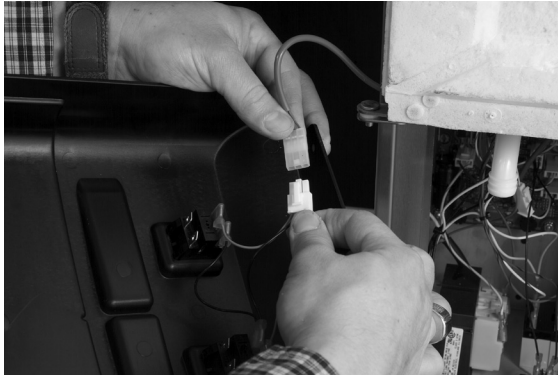

JDF-2S

P3577

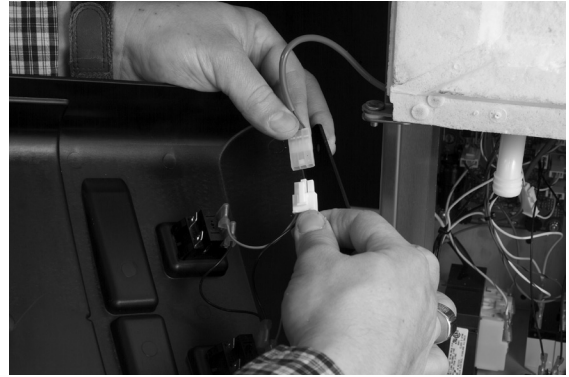

JDF-4S

P3577

2. On Portion Control models, connect membrane switches to Door Circuit Board.

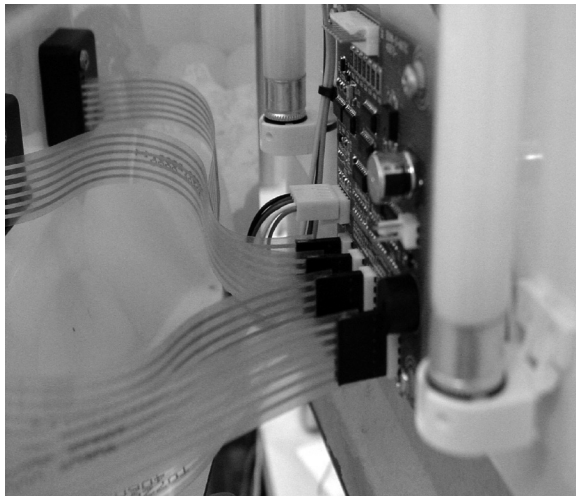

JDF-4S Shown

3. Install door cover



JDF-2S & JDF-4S

P3578

4. Secure the door cover using 5 screws provided.



JDF-2S

P3579



JDF-4S

P3840

PLUMBING HOOKUP

The plumbing connection is located on the rear of the dispenser. A 3/8" (9.52 mm) male flare adapter fitting is supplied, installed on the rear of the dispenser.

NOTE - Water pipe connections and fixtures directly connected to a potable water supply shall be sized, installed and maintained in accordance with federal, state and local codes.

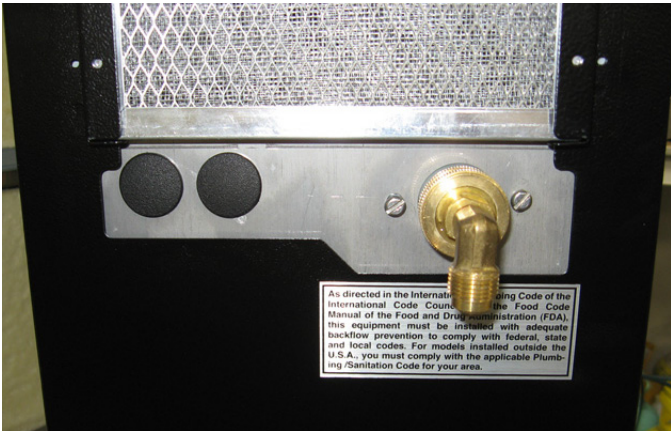

FIG 1 Plumbing Connections - JDF-2S

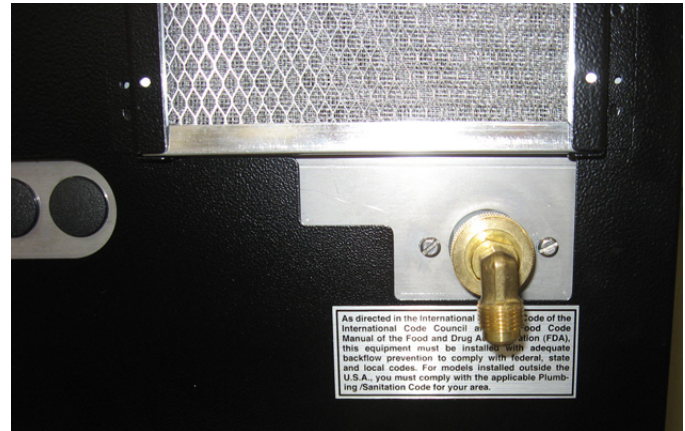

FIG 2 Plumbing Connections - JDF-4S

INITIAL FILL

CAUTION: The dispenser must be disconnected from the power source throughout the initial fill except when specified in the instructions.

1. Remove drip tray assembly and splash panel from the dispenser. Replace the drip tray.
2. Connect the water source to the back of the dispenser.
3. Pull the fill tube from the dispenser, remove the plug and connect it to the dispense nozzle.
4. Set the Program Switch (near main control board) to the ON position. (On older models without program switch, set the Dispense Lockout Switch to the OFF position)
5. Connect dispenser to the power source. Press and hold the dispense button for the dispense station that the tube is connected to for 10 seconds, until you hear the water valve turn on. (For Portion Control machines, press and hold the **PLUS/STOP** switch)
6. Monitor the water bath fill level until water starts to trickle from the overflow tube. Then press the dispense button again to stop the fill process.

NOTE: The fill timer may time out before filling is complete. Press and hold the dispense button for 10 seconds to start again if needed.



FIG 3 Initial Fill Hose - JDF-2S

P3581-1

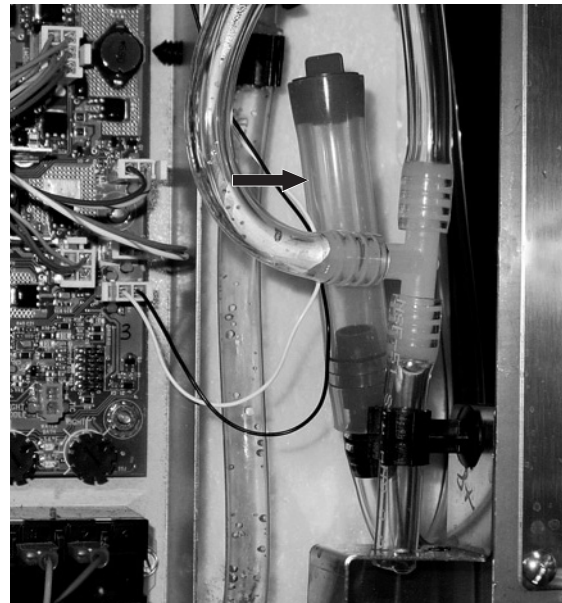
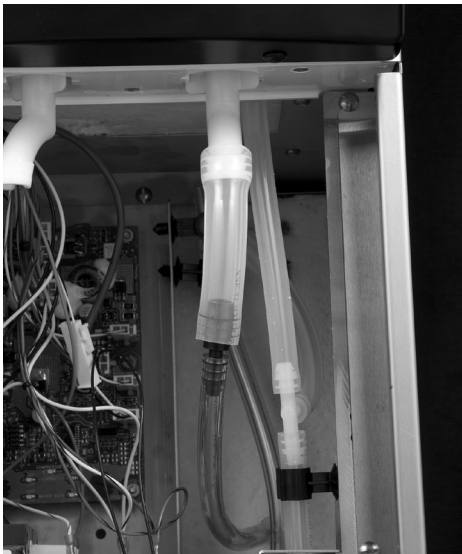

FIG 4 Initial Fill Hose - JDF-4S

P3846

INITIAL FILL (Continued)

7. Turn ON the refrigeration switch near the main control board. This will start the water bath pump circulation.
8. Check water level in the overflow tube and top off the tank if necessary (Step 5).
9. Disconnect the fill tube and allow excess water to drain into the drip tray. Replace the plug in the end of the fill tube and store back into the dispenser.
10. Set the Program Switch (near main control board) to the OFF position. (On older models without program switch, set the Dispense Lockout Switch to the ON position)
11. Replace the splash panel and drip tray.
12. It will take several hours to create the ice bank required for full dispenser performance. During this time, some further trickling from the water bath is expected due to expansion caused by ice bank formation. While the refrigeration system is creating the ice bank, the dispenser may be readied for use as described in *Loading, Priming and Adjustment*.



P3582

FIG 5 Initial Fill Connection - JDF-2S



P3842

FIG 6 Initial Fill Connection - JDF-4S

OPERATING CONTROLS

Refrigeration Switch

The refrigeration switch is located on the Electrical Panel of the dispenser near the Circuit Board. This switch controls power to the water bath pump and relay contacts for the compressor and condenser fan motor.

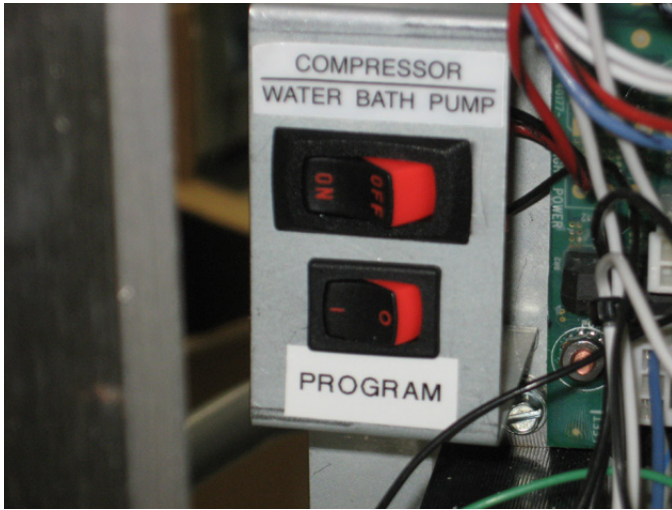

FIG 7 Refrigeration Switch - JDF-2S

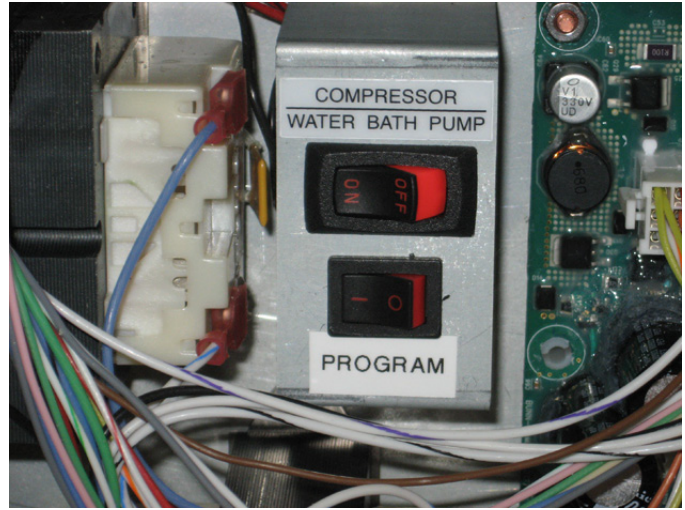

FIG 8 Refrigeration Switch - JDF-4S

Product Dispense Switch (Mechanical Switch Machines)

Pressing and holding switch will initiate product flow from the respective nozzle; releasing the switch will stop the flow.



FIG 9 Product Dispense Switches - JDF-2S

P3583



FIG 10 Product Dispense Switches - JDF-4S

P3844

OPERATING CONTROLS (Continued)

Product Dispense Switch (Membrane Switch Machines)

A. Product Dispense Switch

Momentarily pressing and releasing one of the switches will initiate a timed dispense. Each station has three different timed dispenses which are preset at the factory. Refer to DISPENSER USE section for preset volumes and adjustment procedures.

B. Plus/Stop Switch

This switch can be used to “top-off” a beverage. Pressing and holding switch will initiate product flow from the respective nozzle; releasing the switch will stop the flow. Momentarily pressing this switch during a timed dispense will stop the flow.

C. Chilled Water Dispense Switch (Optional for JDF-4S only)

Pressing and holding switch will initiate chilled water flow from the nozzle; releasing the switch will stop flow.



FIG 11 Product Dispense Switches - JDF-2S



FIG 12 Product Dispense Switches - JDF-4S

Dispense Lockout Switch (JDF-2S shown)

This switch is located at the bottom front of the dispenser just behind the drip tray. It is used to turn ON and OFF the Dispensing function. It is also used for some programming and fill procedures.

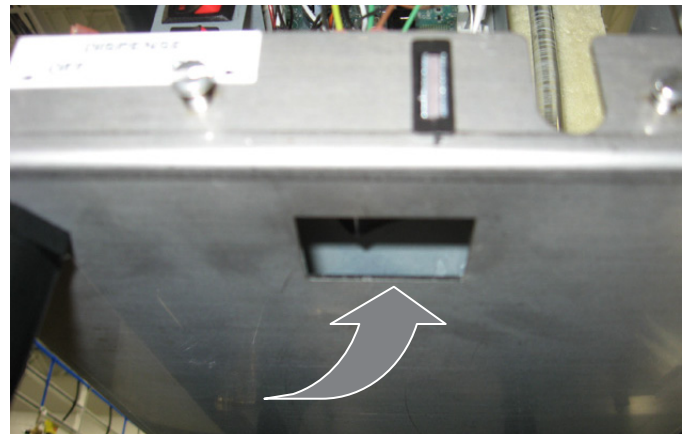

FIG 13 Dispense Lockout Switch

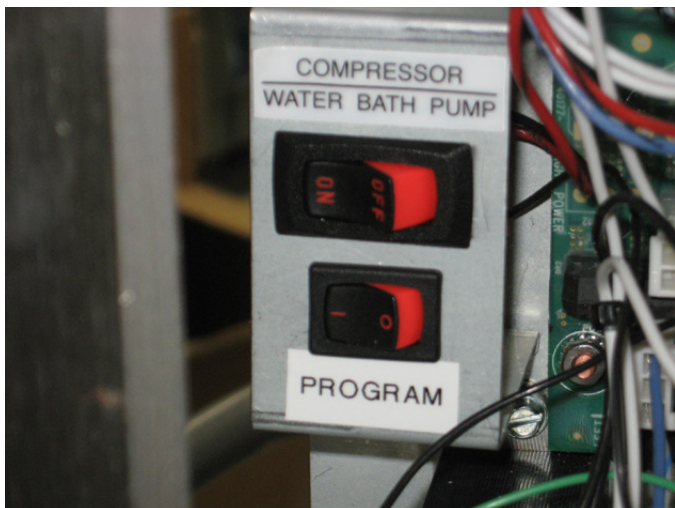

FIG 14 Program Switch

Program Switch (JDF-2S shown)

This switch is located near the main control board next to the refrigeration switch.

OPERATING CONTROLS (Continued)

DISPENSER USE

Press and Hold Dispensing:

1. Place a cup on the drip tray beneath the desired dispensing nozzle.
2. Press and hold the "Product Dispense" switch until the beverage reaches the desired level, then release.

Portion Control Option (Mechanical Switch Machines)

The dispenser is also equipped with a portion control option. The following steps will guide you through the set up process for this option. Portion control can be set on one or all dispense heads as needed.

1. Unplug dispenser from power source.
2. Set the Program Switch (near main control board) to the ON position. (On older models without program switch, set the Dispense Lockout Switch to the OFF position)
3. Remove drip tray and splash panel from the front of the machine then replace the drip tray.
4. Press and hold the left most (Station 1) dispense switch while plugging the dispenser into the power source. Continue holding dispense switch(s) until all 4 temperature LED's, Figs. 15 and 16 on the circuit board start flashing slowly (this takes about 5 seconds). Release dispense switch(s).
5. Press and release any dispense switch 6 times to enter the portion control set up mode. This will cause the 4 temperature LED's to flash rapidly.
6. Place a container under the desired dispense nozzle to measure the portion size.
7. Press and hold the desired dispense switch to dispense product until the desired amount of product is achieved. (Maximum dispense time is 25 seconds). Repeat this on all dispense heads as desired.
8. Set the Program Switch (near main control board) to the OFF position. (On older models without program switch, set the Dispense Lockout Switch to the ON position)
9. Place a container under the dispense nozzle(s) and press the dispense button to confirm that the portion size is set correctly. Repeat steps 1-8 if any changes are needed.
10. Replace splash panel.

Note: The portion control dispense can be cancelled during a dispense by pressing the dispense button again.

Note: If a portion size is not set for a dispense head while in the portion control set up mode, that dispense head will remain a push and hold dispense head.

Push and Hold Membrane Switch Machines

1. To set single portion sizes on a push and hold membrane type dispense switch, follow steps 1 - 10 above.

Portion Control Option (Membrane Switch Machines)

Portion sizes are preset but can be adjusted by following these steps below.

1. Set the Program Switch (near main control board) to the ON position. (On older models without program switch, set the Dispense Lockout Switch to the OFF position)
2. Press and hold the large and medium buttons on the left most (Station #1) dispense station until you hear the machine "beep" three times.
3. Place a measuring container under the station to be adjusted, then press and hold the appropriate dispense switch until the desired amount is dispensed. The machine will record the amount of time that the button is pressed continuously. If the button is released too soon, simply empty the container and start over.
4. Repeat step 3 for all stations as desired.
5. Turn the program switch to the OFF position.

OPERATING CONTROLS (Continued)

Procedure to return all dispense heads back to Push and Hold mode (Mechanical Switch Machines):

1. Unplug dispenser from power source.
2. Place Program switch in the ON position.
3. Remove drip tray and splash panel from the front of the machine then replace the drip tray.
4. For the JDF-2S, press and hold either dispense switch while plugging the dispenser into the power source. For the JDF-4S, press and hold two left dispense switches while plugging the dispenser into the power source. Continue holding dispense switch(s) until all 4 temperature LED's on the circuit board start flashing slowly (this takes about 5 seconds). Release dispense switch(s).
5. Press and release any dispense switch three times.
6. Place Program switch back into the OFF position.
7. Replace splash panel and drip tray.
8. Place a container under each dispense nozzle and press dispense buttons to confirm machine is operating in push and hold mode.

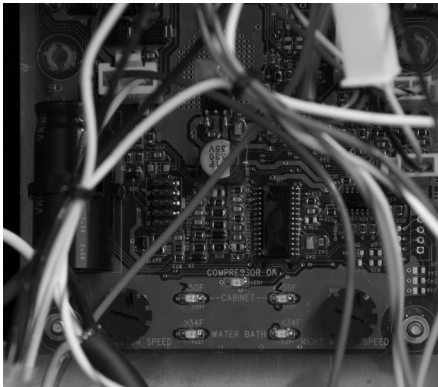

P3585

FIG 15 Temperature LEDs JDF-2S
(Early Models)

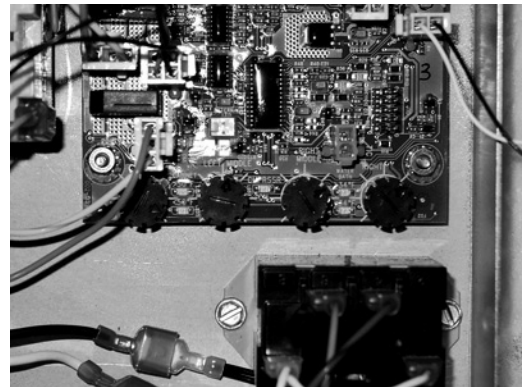

P3845

FIG 16 Temperature LEDs JDF-4S

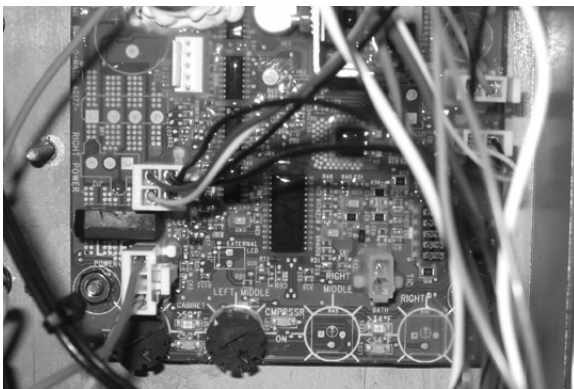

FIG 15A Temperature LEDs JDF-2S
(Late Models)

CLEANING & PREVENTIVE MAINTENANCE

Daily: Rinse Procedure

Tools required: 32 oz. (946 ml) minimum empty container

1. Open dispenser door. Lift up on product containers and remove them from the machine.
2. Close the door, place an empty container under the dispensing nozzle.
3. Dispense from each station until clear water flows from the dispense nozzle.
4. Open dispenser door and reconnect all product containers.

Daily: Parts Washing

1. Remove and wash the dispense nozzle(s), mixing element(s), drip tray and drip tray cover in a mild detergent solution. Rinse thoroughly.
2. Wipe splash panel, areas around dispense nozzle(s), and refrigerated compartment with a clean, damp cloth.

Sanitize Process for Semi-Automatic and Manual

Tools required: 1 empty 5 gallon (18.9 L) bucket, 2 packets of Kay 5 sanitizer, and clean, empty concentrate container.

1. Remove all concentrate from the dispenser and store in a separate refrigerated compartment.
2. Fill clean empty concentrate container(s) with approximately 32 oz. (946 ml) of hot tap water (approximately 140 Deg. F (60 Deg. C). Load the containers of hot water into the dispenser (just like concentrate).
3. Place an empty container under the dispense nozzles.
4. Press and hold the dispense button at each station until the stream out of the nozzles runs clear (about 30 seconds).
Note: the dispenser will not allow all stations to run at the same time.
5. Once this is completed, remove the container(s) and empty.
6. Remove each dispense nozzle and mixing element and run under hot tap water to remove excess pulp.
7. Prepare 2.5 gal. (9.46 L) of sanitizing solution by dissolving 1 packet of Kay 5 sanitizer into 2.5 gal. (9.46 L) of 120 Deg F (48.9 Deg. C) water to ensure 100 ppm of available chlorine.
8. Place nozzle(s) and mixing element(s) in a separate 1-quart container of sanitizing solutions and mix thoroughly. Allow the parts to soak for 2 minutes.
9. Clean the dispense nozzle receptacle(s) (dispense valves) with the sanitizing solution and a soft bristle brush.
10. Clean the concentrate bottle's inlet adapter(s) using the sanitizing solution and a soft bristle brush.
11. Replace the mixing element(s) and nozzle(s).
12. Fill approximately 128 ounces (3.8 L) of clean sanitizing solution into clean, empty concentrate container(s). Do not use the sanitizing solution used in step 10. Load the container(s) into the dispenser.
13. Place the empty 5 gallon bucket under the dispense nozzles.

For Semi-Automatic Sanitizing Prior to S/N JDF0016500:

14. a. For the JDF-2S, press and hold both dispense buttons for about 10 seconds to initiate the sanitize cycle.
b. For the JDF-4S, press and hold three left most dispense buttons (Stations 1, 2 and 3) for about 10 seconds to initiate the sanitize cycle. The cycle will start with only one of the dispense stations dispensing. Note: The cycle will consist of a 1 minute dispense time (alternating) on each station, then 5 minutes of soak time, then a 2 minute dispense time (alternating) on each station.

For Semi-Automatic Sanitizing Effective S/N JDF0016500 and up:

14. Turn the Program Switch in the bottom of the machine to the "ON" position.
 - a. For the JDF-2S, press the left dispense button 2 times, then press the right dispense button 2 times.
 - b. For the JDF-4S, press the left most (station 1) dispense button 2 times, then the left center (station 2) button 2 times. The cycle will start with only one of the dispense stations dispensing. Note: The cycle will consist of a 1 minute dispense time (alternating) on each station, then 5 minutes of soak time, then a 2 minute dispense time (alternating) on each station.

For Manual Sanitizing:

14. a. Dispense each station for 1 minute.
 - b. Allow to soak for 5 minutes.
 - c. Dispense each station for 2 minutes.

NOTE: On Portion Control models, use the plus/stop switches.

15. When the above cycle is complete, Remove the sanitizing solution and replace with concentrate.
16. At each station, press and hold the dispense switch until product appears. Then dispense one 12 ounce (354.9 ml) glass of finished product and discard.
17. Wipe internal and external surfaces with a clean, damp cloth.

CLEANING (cont)

Monthly: Clean Condenser Coils

1. Use a soft bristle brush to clean the build up of dirt in the condenser.

NOTE: Some models include a removable filter that can be cleaned in warm soapy water.

Annually: Check water level in ice bath. Top off if needed.

Annually: Replace Pump Tubing

39690.0000	Tube Kit JDF-2S & JDF-4S
39688.0000	Tube Assembly

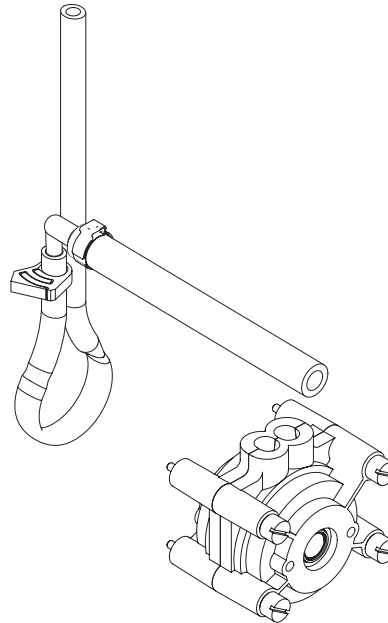

1. Open dispenser door.
2. Remove all product containers and place them in a refrigerated (35-40 degrees F [1.6-4.4 degrees C]) environment. Disconnect all connections to ambient products from the bottle adapter.
3. Rinse all dispense stations using steps outlined in "DAILY RINSE PROCEDURE".
4. Disconnect dispenser from power source.
5. Remove the dispense platform cover.
6. Disconnect the dispense platform water line(s) from the supply line inside the refrigerated cabinet and disconnect the wiring connection(s) from the cabinet receptacle(s).
7. Remove the mounting screw(s) securing the dispense platform(s) to the cabinet .
8. Pull the dispense platform(s) completely out of the cabinet and place it on a flat work surface.
9. Close the dispenser door.
10. Remove the 4 screws securing the pump head.
11. Gently pull the pump head apart.
12. Gently pull the pump tube from around the pump's rotor.
13. Release the clamps securing the old pump tubing to the plastic elbows.
14. Pull the plastic elbows from the old pump tubing, and discard the old pump tubing.
15. Insert the plastic elbows into the new pump tubing and secure it with the clamps.
16. Gently wrap the new pump tubing around the pump's rotor.
17. Reassemble the pump housing onto the platform assembly.
18. Repeat steps 10 through 17 for the remaining pump(s).
19. Replace the dispense platform(s) into the refrigerated cabinet, making sure to reconnect all electrical and water connections.
20. Replace the dispense platform cover.
21. Turn power on to dispenser.
22. Install containers of rinse water, run each station and check for leaks. Repair leaks as necessary.
23. Replace product shelf and product containers. Reconnect any connections to ambient product containers.
24. Prime the pumps as described in "PRIMING" in the Initial Fill Section.

ADJUSTMENT & OPTIONAL SETTINGS

Water Flow Testing and Adjustment

NOTE: Purge all dispense stations to remove air from water line before making initial adjustments.

1. Place a graduated measuring cup or the large chamber of the empty brewing cup (BUNN-O-MATIC part number 33095.0000) under the appropriate dispense nozzle. Place the Program switch in the ON position.
2. Press and release the desired "Product Dispense Switch" three times. (On Portion Control models, use the plus/stop switches)
3. The selected position will dispense water (no concentrate) only for 3 seconds.
4. Measure the water dispensed.
5. Adjust the water flow rate Fig 17, (clockwise to increase flow rate; counterclockwise to decrease flow rate) to the corresponding product mix ratio as follows:

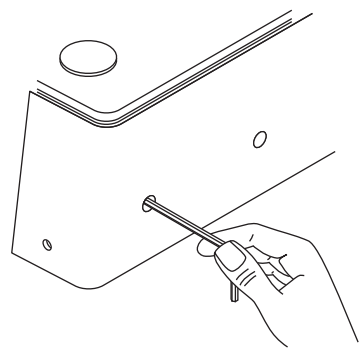

P3586

FIG 17 Adjusting Water Flow Using 1/4" allen wrench

Mix Ratio (water + concentrate)	Adjust water flow rate to:	Product	Brix %
2+1	*3.75 fl. oz (111 ml) per 3-second test	Prune Juice	16.0%
		Other	*
4+1	*4.0 fl. oz (118 ml) per 3-second test	Orange Juice	11.8%
		Pineapple Juice	12.8%
		Cranberry Fruit Cocktail	14.0%
5+1	*4.0 fl. oz (118 ml) per 3-second test	Grapefruit Juice	10.6%
		Lemonade	
		Apple Juice	12.0%
		Fruit Punch	
		Grape Juice	13.0%
3+1 through 7+1		Other	*
Above 7+1	*4.0 fl. oz (118 ml) per 3-second test	Other	*
High Viscosity Juice	2.25 - 3.0 fl. oz (66.5 - 89 ml) per 3-second test	As Required	-

*Maximum flow rate may be less depending on the water pressure supply at each location.

Note: Information for specific products listed in this table is to be used for reference only. Consult the product label for exact mix ratio and/or brix %. See product label for target brix %.

6. Repeat steps 1 through 5 as necessary until the correct water flow rate is achieved.
7. Repeat steps 1 through 5 for the remaining dispense positions.
8. Place the Program switch back into the OFF position.

Pump Speed Adjustment

1. Disconnect the dispenser from the power source.
2. Remove the drip tray.
3. Remove the two screws securing the splash panel and remove the splash panel
4. Locate the adjustment knobs on the circuit board.
5. Turn the adjustment knobs clockwise to increase speed and counterclockwise to decrease speed.
6. The knob positions directly correspond to dispense station locations.

NOTE: Some 2S models have 4 adjustment knobs on the circuit board. For these models use the two left most knobs to make pump speed adjustments. Left most being station #1 (left side dispense) and left center being station #2 (right side dispense).

7. Reinstall the splash panel and drip tray and reconnect the dispenser to the power source.

LOADING

Frozen Concentrates

1. Thaw the frozen concentrate in a refrigerated 35-40 degrees F (1.6-4.4 degrees C) environment for 36 to 48 hours before use.
2. Thoroughly mix the thawed concentrate by vigorously shaking the product container.
3. Open the dispenser door.
4. Prior to placing the product container in the dispenser, make sure that the o-ring on the container adapter is lubricated. This will ease removal of the container when it becomes necessary.
5. Place the product container in the desired position and press it firmly into the bottle adapter opening.
6. Open the vent hole in the product container.

Note: Concentrate in the container must be completely thawed and be within the temperature range of 35-40 degrees F (1.6-4.4 degrees C.) Product outside of this temperature range, especially below, will produce an “out of brix” drink.

Ambient Concentrates (Optional)

1. Install an Ambient Concentrate Conversion Kit (BUNN-O-MATIC part number 33699.0002) per the instructions provided in the kit.
2. Attach the concentrate product hose to the appropriate concentrate line located at the rear of the dispenser.
3. Attach the other end of the product hose to the product container through an appropriate fitting.

PRIMING

1. Open the dispenser door
 2. Load concentrate per instructions in section titled *Loading*.
 3. Close the dispenser door.
 4. Place a large container under the appropriate dispense nozzle.
- Press and hold the “Product Dispense Switch” Fig 5, until concentrate dispenses from the dispense nozzle.

Note: This may take several seconds, depending on the installation and set pump speed.

ADJUSTMENT & OPTIONAL SETTINGS (cont)

Total Dispense Ratio Set Up Procedure

1. Adjust water flow as described in **Water Flow Testing and Adjustment**. Record water output setting for later reference on each dispense head.
 2. Place the Program switch in the ON position.
 3. Place a measuring container under the dispense nozzle, press and release the DISPENSE button 6 times.
- NOTE:** For best results, discard the first sample and measure a second sample. Repeat the same practice after every adjustment.
4. Record the total ounces dispensed.
 5. Refer to the Brix/Ratio chart below to confirm proper total dispensed amount for ratio desired and water output previously recorded.
 6. To increase or decrease the product output, refer to **Pump Speed Adjustment** section.
 7. Place the Program switch back into the OFF position.

3 second water dispense in ounces	Ratio Target										
	2:1	3:1	4:1	5:1	6:1	7:1	8:1	9:1	10:1	11:1	12:1
1.5	2.25	2.00	1.88	1.80	1.75	1.71	1.69	1.67	1.65	1.64	1.63
1.75	2.63	2.33	2.19	2.10	2.04	2.00	1.97	1.94	1.93	1.91	1.90
2.0	3.00	2.67	2.50	2.40	2.33	2.29	2.25	2.22	2.20	2.18	2.17
2.25	3.38	3.00	2.81	2.70	2.63	2.57	2.53	2.50	2.48	2.45	2.44
2.5	3.75	3.33	3.13	3.00	2.92	2.86	2.81	2.78	2.75	2.73	2.71
2.75	4.13	3.67	3.44	3.30	3.21	3.14	3.09	3.06	3.03	3.00	2.98
3.0	4.50	4.00	3.75	3.60	3.50	3.43	3.38	3.33	3.30	3.27	3.25
3.25	4.88	4.33	4.06	3.90	3.79	3.71	3.66	3.61	3.58	3.55	3.52
3.5	5.25	4.67	4.38	4.20	4.08	4.00	3.94	3.89	3.85	3.82	3.79
3.75	5.63	5.00	4.69	4.50	4.38	4.29	4.22	4.17	4.13	4.09	4.06
4.0	6.00	5.33	5.00	4.80	4.67	4.57	4.50	4.44	4.40	4.36	4.33

3 second water dispense in milliliters	Ratio Target										
	2:1	3:1	4:1	5:1	6:1	7:1	8:1	9:1	10:1	11:1	12:1
44.4	66.5	59.1	55.5	53.2	51.8	50.7	49.9	49.3	48.8	48.4	48.1
51.8	77.6	69.0	64.7	62.1	60.4	59.1	58.2	57.5	56.9	56.5	56.1
59.1	88.7	78.9	73.9	71.0	69.0	67.6	66.5	65.7	65.1	64.5	64.1
66.5	99.8	88.7	83.2	79.8	77.6	76.0	74.9	73.9	73.2	72.6	72.1
73.9	110.9	98.6	92.4	88.7	86.3	84.5	83.2	82.1	81.3	80.7	80.1
81.3	122.0	108.4	101.7	97.6	94.9	92.9	91.5	90.4	89.5	88.7	88.1
88.7	133.1	118.3	110.9	106.5	103.5	101.4	99.8	98.6	97.6	96.8	96.1
96.1	144.2	128.1	120.1	115.3	112.1	109.8	108.1	106.8	105.7	104.8	104.1
103.5	155.3	138.0	129.4	124.2	120.8	118.3	116.4	115.0	113.9	112.9	112.1
110.9	166.4	147.9	138.6	133.1	129.4	126.7	124.8	123.2	122.0	121.0	120.1
118.3	177.4	157.7	147.9	141.9	138.0	135.2	133.1	131.4	130.1	129.0	128.1

ADJUSTMENT & OPTIONAL SETTINGS (cont)

Temperature Compensated Refractometer Method

1. Adjust the water flow as described in *Water Flow Testing and Adjustment*.
2. Place an empty container under the appropriate dispense nozzle.
3. Press and hold the “Product Dispense Switch” Figs 9 & 10, until water and concentrate begin flowing freely from the dispense nozzle.
4. Discard the product caught previously and place the empty container back under the dispense nozzle.
5. Press and hold the “Product Dispense Switch” until the cup is filled.
6. Stir the contents of the cup, and use the refractometer (according to the manufacturer’s instructions) to check the brix %.
7. Adjust the pump speed (down to decrease the brix %; up to increase the brix %) to achieve the correct brix % as described in *Pump Speed Adjustment*.

Optional Cold Water Flow Adjustment

Some dispensers are equipped with an optional cold water dispense valve. It is recommended to adjust the flow rate upon initial set up of the dispenser. The adjustment for the cold water can be located inside the dispenser behind the right service panel. The cold water dispense valve is mounted to the frame just above the ice bath. Attached to this valve is a needle type adjustment valve. Turn the adjustment clockwise to decrease the water flow, and counter-clockwise to increase the water flow.

Dispenser Lockout

Dispense functions of the dispenser can be turned-off to prevent unauthorized use of the dispenser, while keeping the refrigeration system running.

1. Locate the Dispense Lockout switch at the bottom front of the dispenser behind the drip tray.
2. Place the switch in the OFF position to prevent dispensing.
3. Place the switch in the ON position to allow dispensing.

NOTE: This switch will also operate the door lights on models equipped with this feature.

FUNCTION LIST

Circuit Board LED Indicators - JDF-2S (Early Models)

LED #	LED Color	Illuminates:
1	Green	When the compressor should be ON.
2 Cabinet	Red	When the cabinet temperature is above 50 degrees F.
		Flashes slowly when cabinet temperature exceeds 50 degrees F for 4 hours. Dispense functions are locked out under this condition. Power down the dispenser to reset.
		Flashes rapidly if dispense is attempted in lockout condition.
		Open cabinet thermistor circuit will flash #2 and #3 LED's 1 time every 3 seconds.
		Shorted cabinet thermistor will turn #2 and #3 LED's on steady.
3 Cabinet	Green	When cabinet temperature is below 50 degrees F.
4 Bath	Red	When bath temperature is above 34 degrees F.
		Flashes slowly when compressor is in a 6 minute delay period.
		Open bath thermistor circuit will flash #4 and #5 LED's 1 time every 3 seconds. The compressor will not run under this condition.
		Shorted bath thermistor circuit will flash #4 and #5 LED's 2 times every 3 seconds. The compressor will not run under this condition.
5 Bath	Green	When bath temperature is below 34 degrees F.

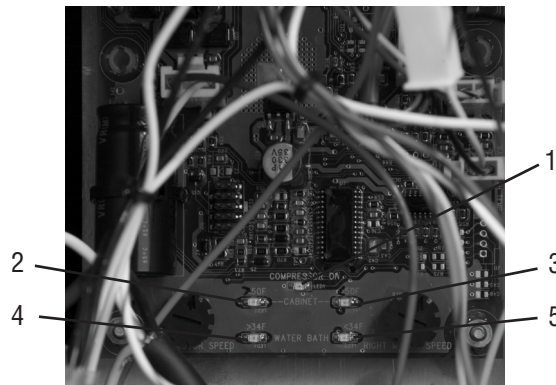

FIG 18 JDF-2S
(Early Models)

P3585

FUNCTION LIST (Continued)

Circuit Board LED Indicators - JDF-4S and Late Model JDF-2S

LED #	LED Color	Illuminates:
1 Bath	Red	When bath temperature is above 34 degrees F.
		Flashes slowly when compressor is in a 6 minute delay period.
		Open bath thermistor circuit will flash #1 and #2 LED's 1 time every 3 seconds. The compressor will not run under this condition.
		Shorted bath thermistor circuit will flash #1 and #2 LED's 2 times every 3 seconds. The compressor will not run under this condition.
2 Bath	Green	When bath temperature is below 34 degrees F.
3	Green	When the compressor should be ON.
4 Cabinet	Red	When the cabinet temperature is above 50 degrees F.
		Flashes slowly when cabinet temperature exceeds 50 degrees F for 4 hours. Dispense functions are locked out under this condition. Power down the dispenser to reset.
		Flashes rapidly if dispense is attempted in lockout condition.
		Open cabinet thermistor circuit will flash #4 and #5 LED's 1 time every 3 seconds.
		Shorted cabinet thermistor will turn #4 and #5 LED's on steady.
5 Cabinet	Green	When cabinet temperature is below 50 degrees F.

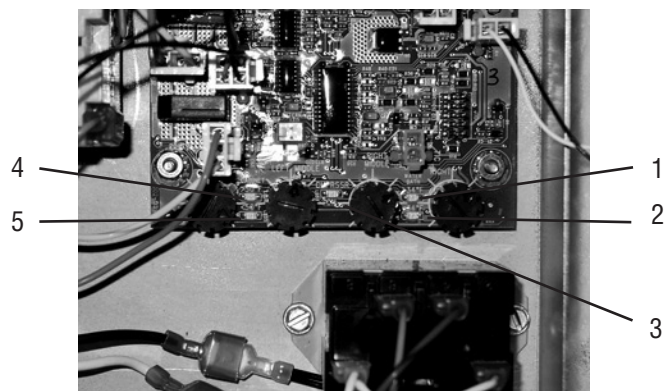

FIG 19 JDF-4S

P3845

TROUBLESHOOTING

A troubleshooting guide is provided to suggest probable causes and remedies for the most likely problems encountered. If the problem remains after exhausting the troubleshooting steps, contact the Bunn-O-Matic Technical Service Department.

- Inspection, testing, and repair of electrical equipment should be performed only by qualified service personnel.
- All electronic components have 120-240 volt ac and low voltage dc potential on their terminals. Shorting of terminals or the application of external voltages may result in board failure.
- Intermittent operation of electronic circuit boards is unlikely. Board failure will normally be permanent. If an intermittent condition is encountered, the cause will likely be a switch contact or a loose connection at a terminal or crimp.
- Solenoid removal requires interrupting the water supply to the valve. Damage may result if solenoids are energized for more than ten minutes without a supply of water.
- The use of two wrenches is recommended whenever plumbing fittings are tightened or loosened. This will help to avoid twists and kinks in the tubing.
- Make certain that all plumbing connections are sealed and electrical connections tight and isolated.

- WARNING –
- Exercise extreme caution when servicing electrical equipment.
 - Unplug the dispenser when servicing, except when electrical tests are specified.
 - Follow recommended service procedures.
 - Replace all protective shields or safety notices.

PROBLEM

Cold Water Circulation

Dispense stations not working.

Note: Cooling failure or excessive cabinet temperatures for more than 4 hours will result in dispense lockout or no dispense.

Note: Reset fault/timer by unplugging unit.

PROBABLE CAUSE

1. Cabinet cooling fan.
2. Bath recirculation pump.
3. Restricted water flow to cabinet water coil and bath.

REMEDY

Replace fan (24vdc).
Note: Fan receives power when the dispenser is powered.

A) If not running, check refrigeration switch and wiring for proper continuity.

B) Check for 120V or 230V AC at pump. Replace pump.

Check for kinked hose.

TROUBLESHOOTING (cont.)

PROBLEM

Refrigeration

Dispense stations not working.

Note: Cooling failure or excessive bath and cabinet temperatures for more than 4 hours will result in dispense lockout or no dispense.

PROBABLE CAUSE

1. Compressor ON/OFF switch.
2. Dirty condenser filter or fins.
3. Condenser fan not running.
4. Compressor relay not activating.
5. Compressor not running.
6. Compressor running and not cooling.

REMEDY

Check for "ON" position or no continuity - replace switch.

Clean filter and fins or replace condenser filter. (Filter not supplied on some machines).

A) Check for 120V or 230V AC. Replace fan motor or check fan blades for obstructions.

B) Check compressor LED on circuit board. If ON, relay coil should have power (120 or 230 VAC).

Check compressor relay coil for 120 or 230vac.

NOTE: Always check power with coil attached. If compressor LED is ON and no 120 or 230vac - replace board. If yes, 120 or 230vac - replace relay.

Note: Relay contacts are normally open.

Check compressor thermal overload (N/C). If open check for dirty condenser filter or adequate ventilation and space around machine.

Check refrigeration system for leaks and proper charge.

Dispenser Locked Out

Dispense stations not working.

1. Check Dispense Lockout switch.

(A) Set switch to ON position.

(B) Check switch and harness for proper continuity.

Cooling system failure.

1. Refrigeration or cold water recirculation system.

Check all previous items that pertain to refrigeration or cold water recirculation

TROUBLESHOOTING (cont.)

PROBLEM

Dispense station not working

PROBABLE CAUSE

1. Dispense Lockout switch set to OFF position.

2. Dispense switch failed

REMEDY

Place switch in ON position.

Check switch and harness for proper continuity.

All stations dispense concentrate only

Main water supply

Check for ON position.

Frozen bath

A) Compressor relay/contacts shorted - replace relay.

B) Recirculating pump - replace or check for kinked flex line.

Inlet water valve failed

A) Check for 120V or 230V power when dispensing. If yes, replace valve. If no, check harness for proper continuity. Then replace circuit board if needed.

TROUBLESHOOTING (cont.)

PROBLEM

Dispense station
concentrate only

PROBABLE CAUSE

Water solenoid

REMEDY

Replace solenoid (24vdc) or check wire connection between water valve and main control board.

Dispense station
water only

Concentrate out

Replace refill concentrate container or BIB

Product pump not pumping

Check for proper counterclockwise rotation of pump rollers. If counterclockwise, replace pump tubing. If clockwise, wire connection to pump is reversed. Switch wires on terminals.

Pump not turning

A) Check speed setting on circuit board and increase speed (turn clockwise)

B) Check for d.c. power to pump motor. If yes, replace motor assy. If no, check harness for proper continuity. Then replace circuit board if needed.

TROUBLESHOOTING (cont.)

PROBLEM

PROBABLE CAUSE

REMEDY

Water leak filling drip tray or around dispense deck area

1. Initial fill/setup

Some expansion normal. May fill drip tray during initial ice block formation

2. Dispense deck

Inspect or replace fittings clamps, o-rings, solenoids and quick disconnect fittings.

NOTE: Dispense deck area slopes to drain tube that leads to the drip tray.

3. Water pressure greater than 100psi

Install water pressure regulator and reduce to 50 psi.

Water leaking beneath machine

1. Bath tank overflow.

A) Check all internal water connections.

B) Check internal plumbing connections.

2. Condensation from cabinet cooling coil.

Check for routing of condensation tube to water bath.

Erratic spray during dispense

Dispense nozzle mixer missing or broken

Replace mixer.

Dispense nozzle dripping water

Dispense solenoid.

Replace dispense deck solenoid.

TROUBLESHOOTING (cont.)

PROBLEM

PROBABLE CAUSE

REMEDY

Unit is not working

1. Step-down transformer.

Check for 120/24 or 230/24 vac. If no 24vac reading, replace step-down transformer.

2. Main control board.

If 24 vac present and no LED's lit, replace control board..

Difficulty brixing and/or weak beverage

1. Product viscosity or too cold.

Thorough thaw of product before use (35° - 40°)

2. Low water pressure.

Maintain 20 psi or higher and a minimum flow rate of 3 fl oz/sec.

3. High water pressure.

Over 100 psi, install a pressure regulator and set to 50 psi.

4. Dispense valve adjustment setting.

A) Perform 3 second water dispense test. Factory setting is 1.0 oz/sec. Acceptable water flow rate is .-0.8 to 1.5 oz/sec depending on the mix ratio (4+1).

B) Adjust water to proper mix ratio. Once water is set, adjust motor speed to achieve brix %.

5. Brix ratio.

Check for proper brix ratio per product using Total Dispense method and or refractometer method.

Difficulty brixing and/or weak beverage

1. Pump tubing.

Inspect, clean, or replace tubing and pump rotor/rollers for ease of rotation.

2. Use of portable water pump.

A) Follow plumbing requirements for pressure and flow rate.

B) Source another portable pump or water supply that meets requirements.

Difficulty brixing bag-in-box

Vacuum leak

Inspect all lines and connections from bag-in-box connector to bottle adapter assembly.

COOLANT SCHEMATIC DIAGRAM

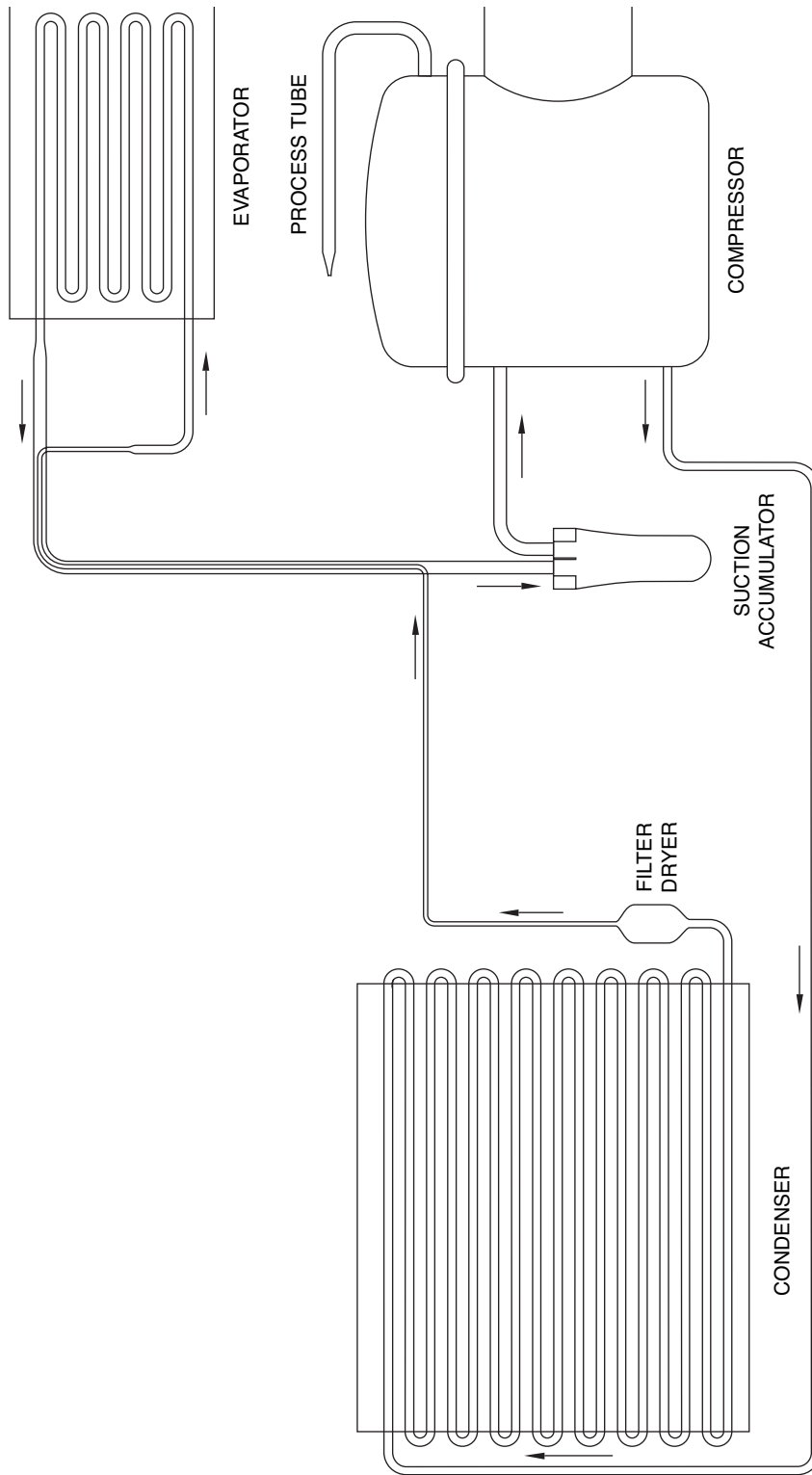

SCHEMATIC WIRING DIAGRAM JDF-2S

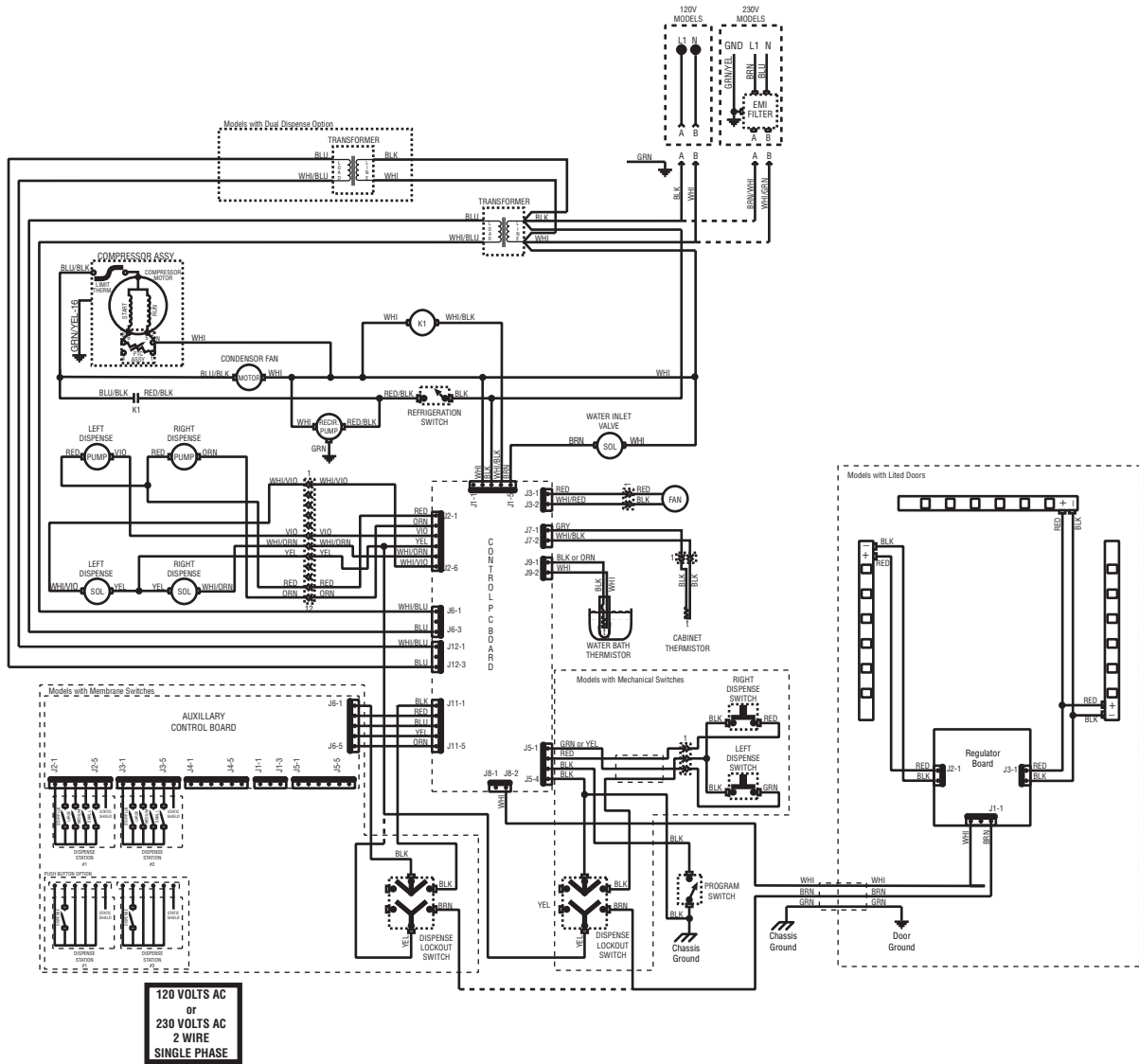

SCHEMATIC WIRING DIAGRAM JDF-4S

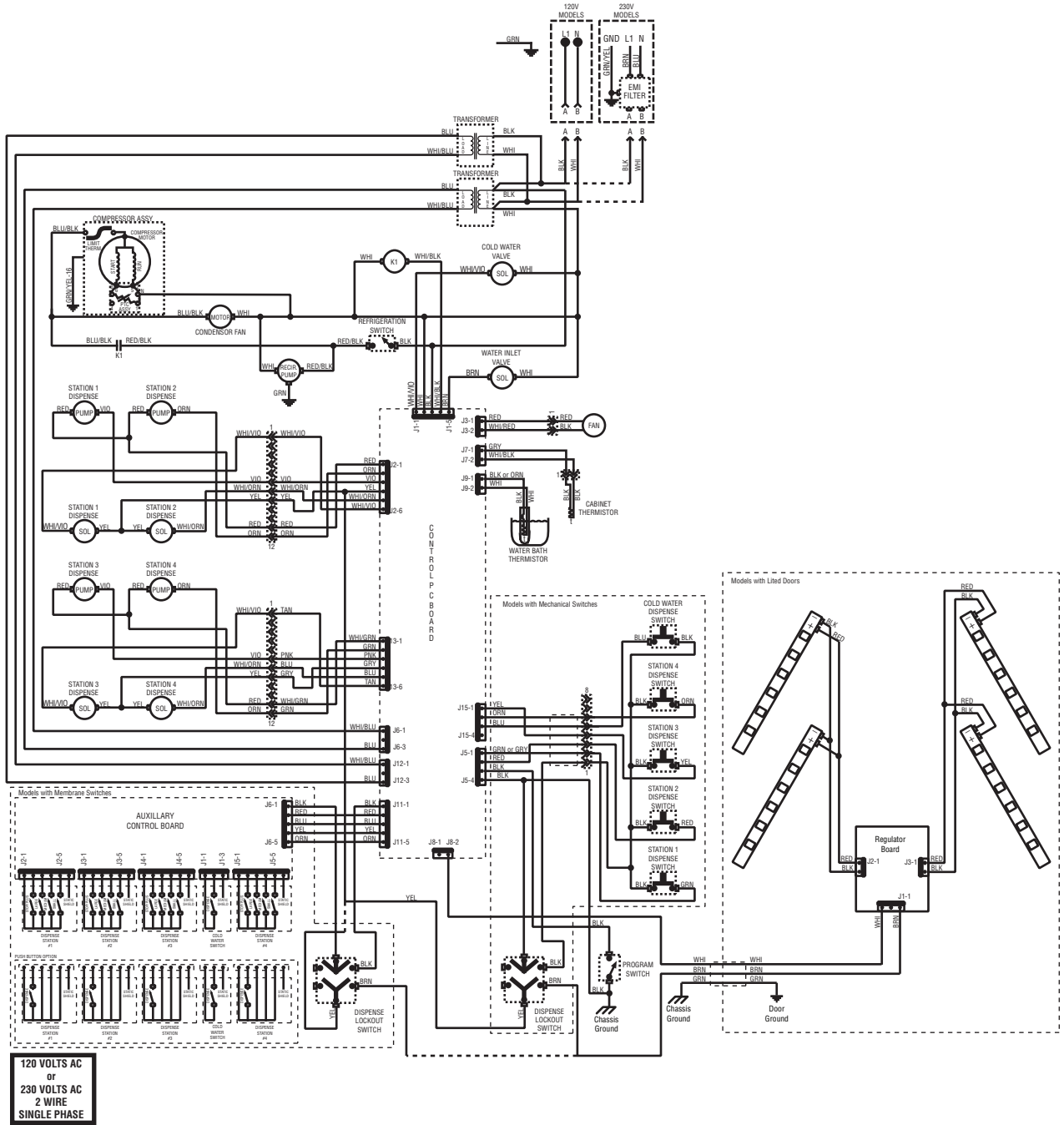

QUICK SETUP GUIDE - JDF-2S and JDF-4S (JDF-2S shown)

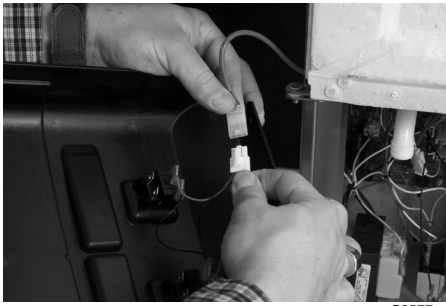

P3577

1. Install door cover by first plugging the door harness connector into the machine harness connector located at the bottom of the machine door.



P3578

2. Install door cover.



P3579

3. Secure the door cover using 5 screws provided.



4. Place refrigeration switch in the OFF position.

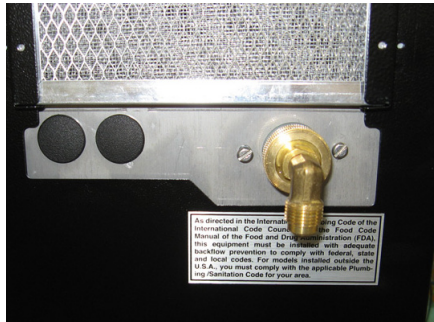

5. Connect water supply to machine. (See *Plumbing Requirements*)

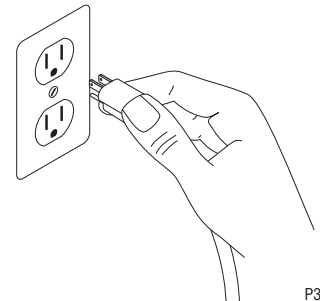

P3588

6. Connect power supply to machine. (See *Electrical Requirements*)

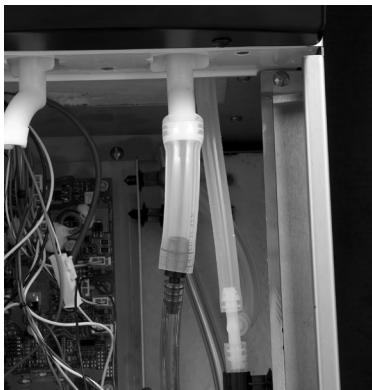

P3582

7. Install bath tank fill tube over a nozzle as shown. (See *Initial Fill*)



8. Place the program switch in the ON position.

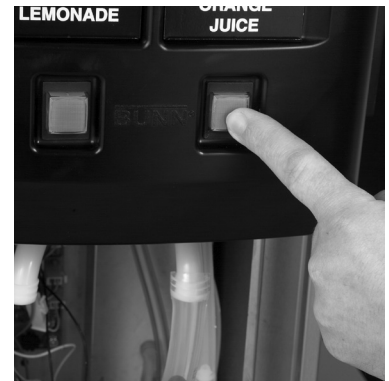

P3589

9. Hold the dispense switch until water begins to flow into the tank (approx. 10 seconds). When tank is full, water will begin pour out of the overflow tube, Press the dispense button to stop the flow of water.

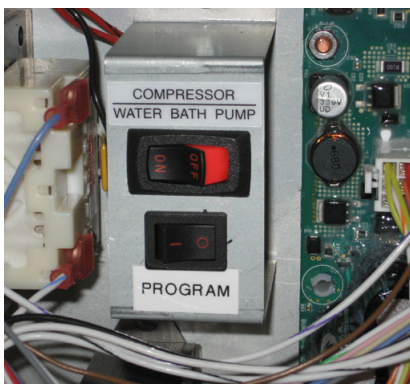

10. Place the refrigeration switch in the ON position and the program switch in the OFF position.



P3591

11. Insert juice containers as shown.

12. Proceed to page 7 in the Operating and Installation manual for calibration instructions and charts.