

# AMERISINK

**ECONOMY**

**TOP MOUNT STAINLESS STEEL SINK**

**AS137**

## Features

- 33" x 22" x 8"
- 18 gauge, 304 type series stainless steel
- 18/10 chrome/nickel content
- Long-lasting, easy-to-clean, brushed finish
- Limited lifetime warranty



## Product Diagram

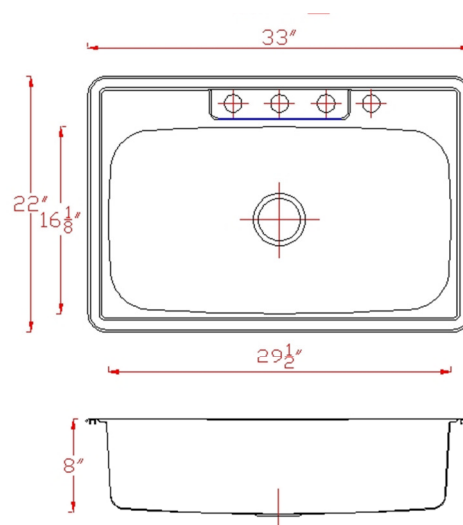

WWW.AMERISINK.COM

877-500-7465

West Coast Warehouse: 510-667-9998 ▲ East Coast Warehouse: 404-691-5088